

IAPD/IPRA CONFERENCE SESSIONS 2017

1	Boardsmanship	Commissioners Round Table	Pat M
2	Boardsmanship	Director and Commissioner Relationships	Craig
3	Boardsmanship	Director and Commissioner Relationships	Pat M
4	Boardsmanship	Director and Commissioner Relationships	Ron E
5	Diversity	Managing Transgender populations & accessibility to public facilities	Colleen
6	Diversity	Grants - More than clicking a button	Sandy
7	Diversity	Grants: More than clicking a button	Katie B
8	Diversity	Transgender: Dealing with the complex issues impacting park district	Eric
9	Diversity	Transgender: Dealing with the complex issues impacting park district	Gary F
10	Diversity	Transgender: Dealing with the complex issues impacting park district	Ron E
11	Diversity	Transgender: Dealing with the complex issues impacting park district	Debbie
12	Diversity	Transgender: Dealing with the complex issues impacting park district	Pat M
13	Facilities	Energy Efficiency Incentives	Craig
14	Facilities	Building blocks of Early Childhood centers	Wendy
15	Finance/IT	GASB New financial reporting module	Lynne
16	Finance/IT	Information Security - safe online	John A
17	Finance/IT	Mobile App	John A
18	Finance/IT	Power Tips and Tricks using Microsoft Excel and Word	Martha
19	Finance/IT	Power Tips and Tricks using Microsoft Excel and Word	John A
20	Finance/IT	Power Tips and Tricks using Microsoft Excel and Word	Wendy
21	Finance/IT	Technology Security everyone in your organization should know	John A
22	Governance/Legal	Hot Topics on Labor Employment	Craig
23	Governance/Legal	Legal Legislative Part I & II	Craig
24	Governance/Legal	Changing your agency's culture to reduce tort exposure	Craig
25	Governance/Legal	FOIA/Open Meetings Act	Eric
26	Governance/Legal	Hot Topics on Labor Employment	Eric
27	Governance/Legal	Legal Legislative Part II	Eric
28	Governance/Legal	New FLSA Regulations	Eric
29	Governance/Legal	Park Wars - The never ending saga	Pat M
30	Governance/Legal	Park Wars - The never ending saga	Ron E
31	HR/Risk Mgmt	Active Threat Emergency Preparedness	Gary F
32	HR/Risk Mgmt	Fraud Risks/Internal Controls	Lynne
33	HR/Risk Mgmt	Interviewing for Results	Sandy
34	HR/Risk Mgmt	Managing and using Drones in Recreational public property	Ron E
35	HR/Risk Mgmt	Managing and using Drones in Recreational public property	Gary B
36	HR/Risk Mgmt	Tips for recruiting the millennial workforce	Martha
37	HR/Risk Mgmt	Tips for recruiting the millennial workforce	Wendy
38	Leadership/Mgmt	Building meaningful relations at work	Colleen
39	Leadership/Mgmt	Building Meaningful Relationships at work	Bill
40	Leadership/Mgmt	Communicate for the Win	Debbie
41	Leadership/Mgmt	Communicate for the Win	Bill
42	Leadership/Mgmt	Communicate for the Win	Dean
43	Leadership/Mgmt	Fire it Up! The power of making Good happen	Debbie
44	Leadership/Mgmt	Game of Thorns	Jody
45	Leadership/Mgmt	Game of Thorns	Debbie
46	Leadership/Mgmt	iLearn 2017; Trending Topics	Colleen
47	Leadership/Mgmt	IPRA Member Engagement	Katie B

IAPD/IPRA CONFERENCE SESSIONS 2017

48	Leadership/Mgmt	Leadership Development - Maximizing your potential	Jody
49	Leadership/Mgmt	Leadership Development - Maximizing your potential	Bill
50	Leadership/Mgmt	Leadership Development - Maximizing your potential	Katie B
51	Leadership/Mgmt	Moving from Management to Transformational Leadership	Colleen
52	Leadership/Mgmt	Next Level Data	Sandy
53	Leadership/Mgmt	Next Level Data	Colleen
54	Leadership/Mgmt	Next Level Data	Dean
55	Leadership/Mgmt	Next Level Data	Gary B
56	Leadership/Mgmt	Using survey research to improve your operation	Sandy
57	Leadership/Mgmt	Using survey research to improve your operation	Colleen
58	Leadership/Mgmt	Using survey research to improve your operation	Martha
59	Marketing/Communicat	Customer Service Bootcamp	John A
60	Marketing/Communicat	Customer Service Bootcamp	Gary F
61	Marketing/Communicat	Invasive Species of the Human Variety	Steve B
62	Marketing/Communicat	Resume Writing and Interview Tips	Lindsay
63	Marketing/Communicat	Tailoring your public process: Engage your community	Lindsay
64	Marketing/Communicat	Throw out the Brochure - Modern Web Marketing	Lindsay
65	Marketing/Communicat	Using Signage and Graphics to promote brand	Lindsay
66	Parks/Natural Resources	Bid process in plain English	Katie B
67	Parks/Natural Resources	Capital Projects - Improving efficiency and success	Steve B
68	Parks/Natural Resources	Maximizing Tree Benefits/3D canopy analysis and the urban forest	Gary B
69	Parks/Natural Resources	Pest Risk Analysis	Steve B
70	Parks/Natural Resources	Up a Creek	Gary B
71	Recreation	Blowing off Steam	Jody
72	Recreation	Captain No Funs guide to safety...	Jody
73	Recreation	Captain No Funs guide to safety...	Gary F
74	Recreation	Enjoy the Ride	Dean
75	Recreation	Enjoy the Ride	Martha
76	Recreation	Enjoy the Ride	Wendy
77	Recreation	Fire, Shelter, Water - Can you survive?	Ron E
78	Recreation	The plight of the middle manager	Colleen
79	Recreation	The Power of Pause	Dean

BOARDSMANSHIP

CONFERENCE EDUCATION SUMMARY FORM

IAPD/IPRA CONFERENCE

JANUARY 2017

PROGRAM SESSION NUMBER # 130 SATURDAY 1/21/17
2:00 - 3:15 PM

TITLE OF SESSION Commissioner's Roundtable

PRESENTER(S) KELLY CHAMBERS, KEVIN BOLAN, JEFF FOUGEROUSSE,
ADRIANE JOHNSON, RON LEHMAN,

1. What knowledge/information was of value to you/Hoffman Estates Park District?

LISTENING TO THE PROBLEMS / ISSUES THAT OTHER BOARDS ARE CHALLENGED WITH INCLUDING BUT NOT LIMITED TO NON-ATTENDING COMMISSIONERS, BAD RELATIONSHIPS BETWEEN VILLAGE / PARK DISTRICTS, LACK OF RESOURCES WHEN THE PARK DISTRICT IS PART OF THE POLICE / FIRE DEPARTMENTS IT HELPS TO PUT IN PERSPECTIVE HOW FORTUNATE WE ARE TO REPRESENT H.E.P.D.

2. Practical applications for HEPD.

- IT IS CRITICAL WE CONTINUE TO MAINTAIN A COHESIVE WELL FUNCTIONING BOARD OF COMMISSIONERS
- IT IS IMPORTANT THAT WE CONTINUE TO MAINTAIN A SOLID RELATIONSHIP WITH THE VILLAGE AS IT IS IN THE BEST INTEREST OF OUR RESIDENTS
- GOOD INTER-GOVERNMENTAL RELATIONSHIPS CAN SAVE TAXPAYER \$'S.
- FINANCIAL STEWARDSHIP, TRANSPARENCY, INTERGOVERNMENTAL COOPERATION ARE KEYS TO THE PARK DISTRICTS SUCCESS.

SUBMITTED BY: Patricia J. McQuinn 1/24/17

PLEASE FILL IN THIS FORM (OR ONE OF YOUR OWN) FOR EACH SESSION YOU ATTEND.
SUBMIT FORM/DOCUMENTATION TO JANE.

AFTER ALL FORMS ARE SUBMITTED, YOU MAY VIEW EVERYONE'S DOCUMENTATION BY LOGGING ONTO GOOGLE DOCS. ENTER USER NAME: BESTAHOFFMAN@GMAIL.COM - PASSWORD: HEPARKS2012 ~ THEY ARE ALSO ON THE DISTRICT'S SHARED DRIVE.

CONFERENCE EDUCATION SUMMARY FORM

IAPD/IPRA CONFERENCE

JANUARY 2017

Saturday 1/24/17
10:15 - 11:30 A.M.

PROGRAM SESSION NUMBER #118

TITLE OF SESSION DIRECTOR / COMMISSIONERS RELATIONSHIPS
CAN FARMERS & COWBOYS BE FRIENDS?

PRESENTER(S) ROBERT K BUSH MIKE CLARK
(PATERNO)

1. What knowledge/information was of value to you/Hoffman Estates Park District?

- RECONFIRMATION THAT THE ATTORNEY WORKS FOR THE DISTRICT / BOARD OF COMMISSIONERS NOT THE EXECUTIVE DIRECTOR THOUGH THEY WORK DIRECTLY WITH THEM. ATTORNEY ALLEGIANCE IS 100% TO THE BOARD.
- THE MAXIMUM CONTRACT IS 3 YEARS BUT GENERALLY THEY ARE ONE YEAR CONTRACTS AS SEVERANCE ISSUES ARE A CONCERN FOR LONGER TERM CONTRACTS
- THE BOARD OF COMMISSIONERS SET THE POLICY AND THE DIRECTORS ARE THE CEO'S THAT STEER THE SHIP ON A DAILY BASIS.

2. Practical applications for HEPD.

- NEED TO CONFIRM IF WE HAVE A POLICY ON WHO CAN CONTACT THE ATTORNEY (I.E. JUST THE PRESIDENT OF THE BOARD OR ANY COMMISSIONER?)
- WE CURRENTLY HAVE ONE YEAR CONTRACTS SO WE HAVE LIMITED ANY SEVERANCE EXPOSURE
- THE BOARD DELEGATES TO THE DIRECTOR ALL HIRING AND FIRING DECISIONS. TO WHAT LEVEL IS A POLICY ISSUE?

SUBMITTED BY: Patrick J. McLean 1/24/17

PLEASE FILL IN THIS FORM (OR ONE OF YOUR OWN) FOR EACH SESSION YOU ATTEND.
SUBMIT FORM/DOCUMENTATION TO JANE.

AFTER ALL FORMS ARE SUBMITTED, YOU MAY VIEW EVERYONE'S DOCUMENTATION BY LOGGING ONTO GOOGLE DOCS. ENTER USER NAME: BESTAHOFFMAN@GMAIL.COM - PASSWORD: HEPARKS2012 ~ THEY ARE ALSO ON THE DISTRICT'S SHARED DRIVE.

CONFERENCE EDUCATION SUMMARY FORM

IAPD/IPRA CONFERENCE

JANUARY 2017

PROGRAM SESSION NUMBER #118

TITLE OF SESSION Director + Commissioner Relationships :
Can Farmers + Cowboys Be Friends?

PRESENTER(S) Robert Bush - Ancil Gluk ; Michael Clark - Palatine PK

1. What knowledge/information was of value to you/Hoffman Estates Park District?

- Not alot of new information here -
- Reminder - Commissioners introduce policy and Directors implement that policy.
- Change of Directors is often a result in the change of commissioners, Director can be solid but can still be involved in change.
- Discussed term limits, no right answer.

2. Practical applications for HEPD.

- Reminder - Attorneys work for the Board and District.
- Relationships are important - Board to Exec Director - Board to Legal Council, Exec Director to Legal Council.
- Policies are important - If you have the right policy in place, you eliminate alot of potential problems. Have the right policy and let your Exec Director do his job.

SUBMITTED BY: Ron Evans - Commissioner

PLEASE FILL IN THIS FORM (OR ONE OF YOUR OWN) FOR EACH SESSION YOU ATTEND. SUBMIT FORM/DOCUMENTATION TO JANE.

AFTER ALL FORMS ARE SUBMITTED, YOU MAY VIEW EVERYONE'S DOCUMENTATION BY LOGGING ONTO GOOGLE DOCS. ENTER USER NAME: BESTAHOFFMAN@GMAIL.COM - PASSWORD: HEPARKS2012 ~ THEY ARE ALSO ON THE DISTRICT'S SHARED DRIVE.

Director and Commissioner Relationships

Valuable information:

Presented by Rob Bush, explored appropriate relationships and boundaries between the Director, staff, and commissioners. Discussions established parameters as to the appropriate contact between the district attorney, commissioners and the director.

Practical applications for HEPD:

The District is already operating within the appropriate parameters for these relationships.

DIVERSITY

CONFERENCE EDUCATION SUMMARY FORM

IAPD/IPRA CONFERENCE

JANUARY 2017

PROGRAM SESSION NUMBER 1003

TITLE OF SESSION Managing Transgender Populations and Accessibility to Public Facilities

PRESENTER(S) Michael Chan, Keri-Lyn J. Krafthefer, Sophie Michaels

1. What knowledge/information was of value to you/Hoffman Estates Park District?

- There are many issues facing transgender ~~issues~~^{people} every day
- People can't be afraid of what they don't know - learn about what the transgender population needs & ~~provide~~ accommodate from there
- Transgender populations can & should be reasonably accommodated in programs & facilities - sometimes needs to be a case-by-case basis

2. Practical applications for HEPD.

- Add policies/procedures for transgender facilities, registration, etc.
- Educate staff & participants about transgender needs & population
- Look at existing programs & facilities to see how transgender participants could be accommodated, if it comes up - sometimes needs to be on a case-by-case basis

SUBMITTED BY: Cellu Palmer

PLEASE FILL IN THIS FORM (OR ONE OF YOUR OWN) FOR EACH SESSION YOU ATTEND. SUBMIT FORM/DOCUMENTATION TO JANE.

AFTER ALL FORMS ARE SUBMITTED, YOU MAY VIEW EVERYONE'S DOCUMENTATION BY LOGGING ONTO GOOGLE DOCS. ENTER USER NAME: BESTAHOFFMAN@GMAIL.COM - PASSWORD: HEPARKS2012 ~ THEY ARE ALSO ON THE DISTRICT'S SHARED DRIVE.

CONFERENCE EDUCATION SUMMARY FORM

IAPD/IPRA CONFERENCE

JANUARY 2017

PROGRAM SESSION NUMBER 1008

TITLE OF SESSION Grants - More than Clicking A Button

PRESENTER(S) Kendall Parrott - Riverdale Park Dist.
& Cathy Splett - NWRSA

1. What knowledge/information was of value to you/Hoffman Estates Park District?

grant station - \$249 for 2 years for finding grants
Tips: Read 3x's, pay atten to specs
Thank the Foundation
Closeout project w/ reports
Review/compare mission statements for
compatibility

2. Practical applications for HEPD.

Review previous ~~grants~~ grantees
Geographic restrictions
Communication/preference
Social media

SUBMITTED BY: Sandy Manisco

PLEASE FILL IN THIS FORM (OR ONE OF YOUR OWN) FOR EACH SESSION YOU ATTEND.
SUBMIT FORM/DOCUMENTATION TO JANE.

AFTER ALL FORMS ARE SUBMITTED, YOU MAY VIEW EVERYONE'S DOCUMENTATION BY
LOGGING ONTO GOOGLE DOCS. ENTER USER NAME: BESTAHOFFMAN@GMAIL.COM -
PASSWORD: HEPARKS2012 ~ THEY ARE ALSO ON THE DISTRICT'S SHARED DRIVE.

6

CONFERENCE EDUCATION SUMMARY FORM

IAPD/IPRA CONFERENCE

JANUARY 2017

PROGRAM SESSION NUMBER # 1008

TITLE OF SESSION Grants: More than clicking a button

PRESENTER(S) Kendall Parrott & Cathy Splett

1. What knowledge/information was of value to you/Hoffman Estates Park District?

This lecture provided the basics of the process of writing & obtaining grants. The grant cycle was discussed, including details of each step from generating ideas to closing out the project.

2. Practical applications for HEPD.

Opportunities exist to research grant resources. Free search engines exist, as well as search engines for a fee. When assessing potential funders, key information includes the mission statement (making sure missions coincide) as well as previous grantees, average grant size, & several additional factors.

SUBMITTED BY: Kate Basile

PLEASE FILL IN THIS FORM (OR ONE OF YOUR OWN) FOR EACH SESSION YOU ATTEND.
SUBMIT FORM/DOCUMENTATION TO JANE.

AFTER ALL FORMS ARE SUBMITTED, YOU MAY VIEW EVERYONE'S DOCUMENTATION BY LOGGING ONTO GOOGLE DOCS. ENTER USER NAME: BESTAHOFFMAN@GMAIL.COM - PASSWORD: HEPARKS2012 ~ THEY ARE ALSO ON THE DISTRICT'S SHARED DRIVE.

CONFERENCE EDUCATION SUMMARY FORM

IAPD/IPRA CONFERENCE

JANUARY 2017

PROGRAM SESSION NUMBER 115

TITLE OF SESSION Transgender Rights

PRESENTER(S) Robert Mc Cabe - Aneel Chhok

1. What knowledge/information was of value to you/Hoffman Estates Park District?

- updates to legal developments regarding transgender rights of employees + patrons

2. Practical applications for HEPD.

- continued drafting/revising of transgender policies for patrons + employees to ensure HEPD remains in legal compliance and attends protections to all parties.

SUBMITTED BY: ETHEL LEVINBERG

PLEASE FILL IN THIS FORM (OR ONE OF YOUR OWN) FOR EACH SESSION YOU ATTEND. SUBMIT FORM/DOCUMENTATION TO JANE.

AFTER ALL FORMS ARE SUBMITTED, YOU MAY VIEW EVERYONE'S DOCUMENTATION BY LOGGING ONTO GOOGLE DOCS. ENTER USER NAME: BESTAHOFFMAN@GMAIL.COM - PASSWORD: HEPARKS2012 ~ THEY ARE ALSO ON THE DISTRICT'S SHARED DRIVE.

CONFERENCE EDUCATION SUMMARY FORM

IAPD/IPRA CONFERENCE

JANUARY 2017

PROGRAM SESSION NUMBER 115

TITLE OF SESSION Transgender: Dealing with the Complex issues impacting P. District

PRESENTER(S) Wendy-Lyn & Robert

1. What knowledge/information was of value to you/Hoffman Estates Park District?

- * Hoffman P.D. / Polaris H.S.
- * Review Transgender Policy with all staff
- * Where do we stand?
- * Our policy - Create Policy before issue.

2. Practical applications for HEPD.

- Point: Review policy w/ all staff
- Hoffman v? add to next Hoffman v? Eric
- * Have all staff sign off on Policy
- * Embrace the Sexuality of the Transgender - "He, she" etc.
- * Must allow Transgender to use restroom locker room that they Affirm / identify with.

SUBMITTED BY: Cindy Fong

PLEASE FILL IN THIS FORM (OR ONE OF YOUR OWN) FOR EACH SESSION YOU ATTEND. SUBMIT FORM/DOCUMENTATION TO JANE.

AFTER ALL FORMS ARE SUBMITTED, YOU MAY VIEW EVERYONE'S DOCUMENTATION BY LOGGING ONTO GOOGLE DOCS. ENTER USER NAME: BESTAHOFFMAN@GMAIL.COM - PASSWORD: HEPARKS2012 ~ THEY ARE ALSO ON THE DISTRICT'S SHARED DRIVE.

CONFERENCE EDUCATION SUMMARY FORM

IAPD/IPRA CONFERENCE

JANUARY 2017

PROGRAM SESSION NUMBER # 115

TITLE OF SESSION Transgender: Dealing with the Complex Issues Impacting Park Districts

PRESENTER(S) Keri-Lyn J. Krafthefer, Robert T. McCabe

1. What knowledge/information was of value to you/Hoffman Estates Park District?

- Terms and Laws are rapidly evolving, they cause emotionally charged reaction and are yet all over the place.
- Laws are so new, that no one is sure on how to enforce. the biggest issue is the fear of how the public will react.
- Transgender individuals are not looking to be a spectacle, they just want to be comfortable in their skin.
- Respect the individual and what he or she is going thru.

2. Practical applications for HEPD.

- Bottom line - Have a policy in place, train your staff and educate them, be prepared for what might or could happen.
- you can enforce your Dress Code policy, it is not discriminatory.
- The first person to encounter a Transgender situation probably will be a young 12 yr old staff member, so keep your policy understandable, in plain English.
- Most situations have found that young people closest to situation handle with no problems, it's the parents that can't deal with it.

SUBMITTED BY: Ron EWANS - Commissioner

PLEASE FILL IN THIS FORM (OR ONE OF YOUR OWN) FOR EACH SESSION YOU ATTEND. SUBMIT FORM/DOCUMENTATION TO JANE.

AFTER ALL FORMS ARE SUBMITTED, YOU MAY VIEW EVERYONE'S DOCUMENTATION BY LOGGING ONTO GOOGLE DOCS. ENTER USER NAME: BESTAHOFFMAN@GMAIL.COM - PASSWORD: HEPARKS2012 ~ THEY ARE ALSO ON THE DISTRICT'S SHARED DRIVE.

CONFERENCE EDUCATION SUMMARY FORM

IAPD/IPRA CONFERENCE

JANUARY 2017

PROGRAM SESSION NUMBER 115

TITLE OF SESSION Transgender: Dealing with the complex issues

PRESENTER(S) Keri-Lyn J Krafthefer impacting Park Districts
Robert T McCabe

1. What knowledge/information was of value to you/Hoffman Estates Park District?

Have a policy before you have a problem
Have policies for both employees & patrons
Staff trainings are imperative on these policies
manuals + sign offs after training

2. Practical applications for HEPD.

- Restrooms - ideally gender neutral otherwise according to gender identity
- Locker Rooms - according to gender identity but private area for transgender + other individuals who do not want to be in a group setting.

SUBMITTED BY: Debra

PLEASE FILL IN THIS FORM (OR ONE OF YOUR OWN) FOR EACH SESSION YOU ATTEND.
SUBMIT FORM/DOCUMENTATION TO JANE.

AFTER ALL FORMS ARE SUBMITTED, YOU MAY VIEW EVERYONE'S DOCUMENTATION BY LOGGING ONTO GOOGLE DOCS. ENTER USER NAME: BESTAHOFFMAN@GMAIL.COM - PASSWORD: HEPARKS2012 ~ THEY ARE ALSO ON THE DISTRICT'S SHARED DRIVE.

CONFERENCE EDUCATION SUMMARY FORM

IAPD/IPRA CONFERENCE

JANUARY 2017

FRIDAY 1/20/17
3:30 - 4:45 p.m.

PROGRAM SESSION NUMBER # 115

TITLE OF SESSION TRANSGENDER: DEALING WITH THE COMPLEX ISSUES IMPACTING PARK DISTRICTS

PRESENTER(S) KERI-LYN J. KRAFT HEFER
ROBERT T. McCABE

1. What knowledge/information was of value to you/Hoffman Estates Park District?

- ABOUT HALF OF THE STATES PROHIBIT DISCRIMINATION BASED ON GENDER IDENTITY. ILLINOIS PROHIBITS DISCRIMINATION
- THE LAWS AND ISSUES ARE NEW SO NOT SURE HOW TO ENFORCE THEM.
- THERE ARE MANY CONFLICTING LAWS, COURT OPINIONS, AND AGENCY DIRECTION. DEVELOPMENTS OCCURRING ALMOST DAILY.
- LAWS BASED ON INDIVIDUAL'S PERSONAL FEELINGS OF GENDER IDENTITY NOT PHYSICAL ANATOMY
- FOR MANY PEOPLE THIS IS A DIFFICULT ISSUE. EMOTIONALLY CHARGED SITUATION. FEAR OF ABUSE OF THE LAWS.

2. Practical applications for HEPD.

- * BEST PRACTICES - HAVE A POLICY IN PLACE BEFORE YOU HAVE AN ISSUE. A POLICY FOR EMPLOYEES AND PATRONS. TRAIN YOUR EMPLOYEES ON THE POLICIES.
- ** POLICY SHOULD INCLUDE CERTAIN THINGS INCLUSIVE
 - WHO TO COMPLAIN TO ABOUT VIOLATIONS
 - RIGHTS OF THE TRANSGENDER INDIVIDUALS IN THE WORKPLACE.
 - EMPLOYEE RESPONSIBLE TO RESPECT RIGHTS
 - EMPLOYER RESPONSIBLE TO ENFORCE POLICY
- *** BE AWARE OF THE DEVELOPING TRENDS AND LAW ON TRANSGENDER RIGHTS AS THEY ARE CHANGING RAPIDLY.

SUBMITTED BY: Patrick J. McLean 1/24/17

PLEASE FILL IN THIS FORM (OR ONE OF YOUR OWN) FOR EACH SESSION YOU ATTEND. SUBMIT FORM/DOCUMENTATION TO JANE.

AFTER ALL FORMS ARE SUBMITTED, YOU MAY VIEW EVERYONE'S DOCUMENTATION BY LOGGING ONTO GOOGLE DOCS. ENTER USER NAME: BESTAHOFFMAN@GMAIL.COM - PASSWORD: HEPARKS2012 ~ THEY ARE ALSO ON THE DISTRICT'S SHARED DRIVE.

FACILITIES

CONFERENCE EDUCATION SUMMARY FORM

IAPD/IPRA CONFERENCE

JANUARY 2017

PROGRAM SESSION NUMBER 406

TITLE OF SESSION Building Blocks of Early Childhood Centers

PRESENTER(S) Tracy Biedersloot, Bruce Dahlquist etc.

1. What knowledge/information was of value to you/Hoffman Estates Park District?

Plan for safety, sustainable solutions, Acoustics,
Daylight/Views children, introduce nature - Biophilic Design

2. Practical applications for HEPD.

- Bonds/Grants - look into them for program
expansion. Specifically "green grants"

SUBMITTED BY: Wendy Storer

PLEASE FILL IN THIS FORM (OR ONE OF YOUR OWN) FOR EACH SESSION YOU ATTEND.
SUBMIT FORM/DOCUMENTATION TO JANE.

AFTER ALL FORMS ARE SUBMITTED, YOU MAY VIEW EVERYONE'S DOCUMENTATION BY
LOGGING ONTO GOOGLE DOCS. ENTER USER NAME: BESTAHOFFMAN@GMAIL.COM -
PASSWORD: HEPARKS2012 ~ THEY ARE ALSO ON THE DISTRICT'S SHARED DRIVE.

Energy Efficiency Incentives for Illinois Park Districts

Valuable information:

We reviewed the **Illinois Energy Now** suite of programs supported by IL DCEO that provides Illinois park districts with incentives for energy efficiency projects, as well as supporting programs for energy assessments and other money saving programs. The Session addressed the ability to get grants for electric work. This involves new construction and replacement of outdated equipment with new energy efficient equipment. Grants will end from the state by 5/31/2017 and monies collected and not spent will be returned to ComEd for either new programs or rebates.

Practical applications for HEPD:

Staff will investigate opportunities for grants in our new construction projects like North side TC. We will investigate for expenditures from our green initiative line items as well.

FINANCE/INFORMATION TECHNOLOGY

CONFERENCE EDUCATION SUMMARY FORM

IAPD/IPRA Conference

JANUARY 2017

PROGRAM SESSION NUMBER _

TITLE OF SESSION GASB New Financial Reporting Module

PRESENTER(S) _____ Fred Lantz/Krisztina Dommer Sikich

1. What knowledge/information was of value to you/Hoffman Estates Park District?

The session spoke to the GASB pronouncements being considered and how they could affect financial statement preparation.

Near Term includes 60-90 days after the end of the reporting period

Short Term includes 12 months after the end of the reporting period

Long Term includes information about all financial resources - simply net worth

GASB has issued an invitation to comment on the financial reporting modules above, comment deadline is March 31, 2017.

Handout information attached.

SUBMITTED BY: _____ Lynne Cotshott _____

**PLEASE FILL IN THIS FORM (OR ONE OF YOUR OWN) FOR EACH SESSION YOU ATTEND.
SUBMIT FORM/DOCUMENTATION TO JANE.**

AFTER ALL FORMS ARE SUBMITTED, YOU MAY VIEW EVERYONE'S DOCUMENTATION BY LOGGING ONTO GOOGLE DOCS. ENTER USER NAME: BESTAHOFFMAN@GMAIL.COM - PASSWORD: HEPARKS2012.

CONFERENCE EDUCATION SUMMARY FORM

IAPD/IPRA CONFERENCE

JANUARY 2017

PROGRAM SESSION NUMBER # 313 1/20/2017 8:15am to 9:30am

TITLE OF SESSION Information Security to keep you safe Online now

PRESENTER(S) Randy Wilson

1. What knowledge/information was of value to you/Hoffman Estates Park District?

The #1 threat of Information security: End Users. More training on best practices is needed. How do we know if we're secure? We're not. It's not absolute, it's a process. Finding the right balance to secure the network (i.e. patching software, strong passwords, screensaver lock, etc.) while not making it too difficult for end users to perform their daily tasks. Useful website: haveibeenpwnd.com will inform you if your email address was part of a breach that occurred. If so, change password immediately. Useful tool: Ninite Pro to patch software efficiently.

2. Practical applications for HEPD.

More Hoffman U training for end users pertaining to safety when browsing the Internet, clicking links on the web or email that may lead to malicious websites, raising awareness of emails that are actually phishing attempts to obtain private information. When performing a Google Search, the first few results will have a small "Ad" icon next to it this is actually a purchased ad by someone else and not necessarily the owners of the website.

SUBMITTED BY: John Agudelo

PLEASE FILL IN THIS FORM (OR ONE OF YOUR OWN) FOR EACH SESSION YOU ATTEND. SUBMIT FORM/DOCUMENTATION TO JANE.

AFTER ALL FORMS ARE SUBMITTED, YOU MAY VIEW EVERYONE'S DOCUMENTATION BY LOGGING ONTO GOOGLE DOCS. ENTER USER NAME: BESTAHOFFMAN@GMAIL.COM - PASSWORD: HEPARKS2012 ~ THEY ARE ALSO ON THE DISTRICT'S SHARED DRIVE.

CONFERENCE EDUCATION SUMMARY FORM

IAPD/IPRA CONFERENCE

JANUARY 2017

PROGRAM SESSION NUMBER #306 1/20/2017 9:45am to 11am

TITLE OF SESSION Park District Mobile App

PRESENTER(S) Omar Sandoval, IT Manager Naperville Park District

1. What knowledge/information was of value to you/Hoffman Estates Park District?

There are Pros & Cons to having a mobile app. Con: It needs to be constantly updated with up to date data & compatibility when a new mobile device OS is introduced. Pro: Everyone uses a mobile device more than computers, convenience, easier to use than a browser on a computer. Naperville uses ActiveNet as oppose to RecTrac at HE Parks. It cost Naperville ~\$13,000 to develop a lot of work internally saved them \$. If outsourced to a vendor the cost is between \$25-30,000.

2. Practical applications for HEPD.

Naperville's app is able to utilize a digital card for members. Instead of swiping in a card, the member opens the app and scans their phone with the digital card open on a scanner. Some members like this as they bring their phone for everything when they workout so they don't have to carry their card. Naperville is also able to utilize push notifications through their app which we have as well. Greygoomedia is the vendor that helped polish Naperville's mobile app.

SUBMITTED BY: John Agudelo

PLEASE FILL IN THIS FORM (OR ONE OF YOUR OWN) FOR EACH SESSION YOU ATTEND. SUBMIT FORM/DOCUMENTATION TO JANE.

AFTER ALL FORMS ARE SUBMITTED, YOU MAY VIEW EVERYONE'S DOCUMENTATION BY LOGGING ONTO GOOGLE DOCS. ENTER USER NAME: BESTAHOFFMAN@GMAIL.COM - PASSWORD: HEPARKS2012 ~ THEY ARE ALSO ON THE DISTRICT'S SHARED DRIVE.

CONFERENCE EDUCATION SUMMARY FORM

IAPD/IPRA CONFERENCE

JANUARY 2017

PROGRAM SESSION NUMBER 328

TITLE OF SESSION Power Tips & tricks Using Excel/Word

PRESENTER(S) Chip Rose

1. What knowledge/information was of value to you/Hoffman Estates Park District?

- Page breaks in same doc - excel
- page break preview, right click insert page break
- page layout, print titles -> sheet -> columns repeat a:a
- formulas -> show formulas

2. Practical applications for HEPD.

- Pivot tables
- Formulas
- color coding rows & columns
- sorting - primary & secondary
- styles - word

SUBMITTED BY: Mahe Houston

PLEASE FILL IN THIS FORM (OR ONE OF YOUR OWN) FOR EACH SESSION YOU ATTEND. SUBMIT FORM/DOCUMENTATION TO JANE.

AFTER ALL FORMS ARE SUBMITTED, YOU MAY VIEW EVERYONE'S DOCUMENTATION BY LOGGING ONTO GOOGLE DOCS. ENTER USER NAME: BESTAHOFFMAN@GMAIL.COM - PASSWORD: HEPARKS2012 ~ THEY ARE ALSO ON THE DISTRICT'S SHARED DRIVE.

CONFERENCE EDUCATION SUMMARY FORM

IAPD/IPRA CONFERENCE

JANUARY 2017

PROGRAM SESSION NUMBER #328 1/20/2017 1pm to 2:15pm

TITLE OF SESSION Power Tips and Tricks Using Microsoft Excel and Word

PRESENTER(S) Chip Rose

1. What knowledge/information was of value to you/Hoffman Estates Park District?

Excel: Conditional Formatting - Create rules to highlight cell values. Formulas - Show Formulas to check if an Excel doc has formulas in any of its cell(s). Autosum, always start with = i.e. = (c3-b3)/c3 or (c3-b3)*.25. \$ symbol locks formula in place, press F4 to make it absolute vlookup, pivot table, sort A-Z, primary & secondary sort by adding levels. Word: Custom margins, setting as default. Indent, translate, styles

2. Practical applications for HEPD.

Business dept. Accounting who deal with a lot of data in spreadsheets could benefit with the information Chip Rose presented. Creating Formulas to calculate % or highlight important values in a cell. Recreation could also benefit with all the data they have on an Excel spreadsheet brightinsight.com is the company that teaches these power tips and tricks as well as more. A lot of these tutorials are also easily found by Google searching.

SUBMITTED BY: John Agudelo

PLEASE FILL IN THIS FORM (OR ONE OF YOUR OWN) FOR EACH SESSION YOU ATTEND. SUBMIT FORM/DOCUMENTATION TO JANE.

AFTER ALL FORMS ARE SUBMITTED, YOU MAY VIEW EVERYONE'S DOCUMENTATION BY LOGGING ONTO GOOGLE DOCS. ENTER USER NAME: BESTAHOFFMAN@GMAIL.COM - PASSWORD: HEPARKS2012 ~ THEY ARE ALSO ON THE DISTRICT'S SHARED DRIVE.

CONFERENCE EDUCATION SUMMARY FORM

IAPD/IPRA CONFERENCE

JANUARY 2017

PROGRAM SESSION NUMBER 328

TITLE OF SESSION Tricks Using Microsoft Excel and Word

PRESENTER(S) Chip Rose

1. What knowledge/information was of value to you/Hoffman Estates Park District?

Unfortunately not a whole lot. The program was geared toward accounting staff. The level of knowledge needed to understand the "Tips / Tricks" was way beyond what I have.

2. Practical applications for HEPD.

SUBMITTED BY: Wendy Stener

PLEASE FILL IN THIS FORM (OR ONE OF YOUR OWN) FOR EACH SESSION YOU ATTEND.
SUBMIT FORM/DOCUMENTATION TO JANE.

AFTER ALL FORMS ARE SUBMITTED, YOU MAY VIEW EVERYONE'S DOCUMENTATION BY LOGGING ONTO GOOGLE DOCS. ENTER USER NAME: BESTAHOFFMAN@GMAIL.COM - PASSWORD: HEPARKS2012 ~ THEY ARE ALSO ON THE DISTRICT'S SHARED DRIVE.

CONFERENCE EDUCATION SUMMARY FORM

IAPD/IPRA CONFERENCE

JANUARY 2017

PROGRAM SESSION NUMBER #311 1/20/2017 3:30pm to 4:45pm

TITLE OF SESSION Technology Security Everyone in your Organization Should Know

PRESENTER(S) Links Technology - Mario, Josh, John, Joey, & Joe

1. What knowledge/information was of value to you/Hoffman Estates Park District?

Be wary of SSIDs (WIFI access points) that are public and open without a password.
i.e. hhonors. Links was able to setup a transparent access point named exactly the same and users connected. Without them knowing, Links was able to grab website information as the user visited various websites. Spyware/Malware, annoying marketing pop ups vs. Viruses, an actual application that destroys data. Be wary of Phishing attempts, fraudulent links that take you to a malicious website.

2. Practical applications for HEPD.

User training, more Hoffman U. We're taking the proper steps by having already implemented:
(1) A Firewall (2) OS Patching (Windows Update) (3) Antivirus & Software updates
(4) Local Administrator permissions. Could do better to educate our users with certain topics like web, email security, etc.

SUBMITTED BY: John Agudelo

PLEASE FILL IN THIS FORM (OR ONE OF YOUR OWN) FOR EACH SESSION YOU ATTEND.
SUBMIT FORM/DOCUMENTATION TO JANE.

AFTER ALL FORMS ARE SUBMITTED, YOU MAY VIEW EVERYONE'S DOCUMENTATION BY LOGGING ONTO GOOGLE DOCS. ENTER USER NAME: BESTAHOFFMAN@GMAIL.COM - PASSWORD: HEPARKS2012 ~ THEY ARE ALSO ON THE DISTRICT'S SHARED DRIVE.

GOVERNANCE/LEGAL

CONFERENCE EDUCATION SUMMARY FORM

IAPD/IPRA CONFERENCE

JANUARY 2017

PROGRAM SESSION NUMBER 317- ~~40~~

TITLE OF SESSION FOIA / OPEN MEETINGS ACT

PRESENTER(S) John Redlonshofer - Heyl + Rogster

1. What knowledge/information was of value to you/Hoffman Estates Park District?

UPDATES to requirements for open meetings -
what can/can-not be discussed.
- safeguarding personal information

2. Practical applications for HEPD.

Guidance for HEPD leadership - what can/should be
discussed in closed executive session / open session

SUBMITTED BY: ERIC LEUBNER

PLEASE FILL IN THIS FORM (OR ONE OF YOUR OWN) FOR EACH SESSION YOU ATTEND.
SUBMIT FORM/DOCUMENTATION TO JANE.

AFTER ALL FORMS ARE SUBMITTED, YOU MAY VIEW EVERYONE'S DOCUMENTATION BY
LOGGING ONTO GOOGLE DOCS. ENTER USER NAME: BESTAHOFFMAN@GMAIL.COM -
PASSWORD: HEPARKS2012 ~ THEY ARE ALSO ON THE DISTRICT'S SHARED DRIVE.

CONFERENCE EDUCATION SUMMARY FORM

IAPD/IPRA CONFERENCE

JANUARY 2017

PROGRAM SESSION NUMBER 319

TITLE OF SESSION Hot Topics in Labor/Employment

PRESENTER(S) Robert McCabe - Ansel Gluck

1. What knowledge/information was of value to you/Hoffman Estates Park District?

- updates in case law pertaining to FMLA/
ADA/workers comp.

2. Practical applications for HEPD.

- Guidance for how to resolve/work through claims
when they are presented, including use of the
employee interactive process.

SUBMITTED BY: ETHEL LEVINSON

PLEASE FILL IN THIS FORM (OR ONE OF YOUR OWN) FOR EACH SESSION YOU ATTEND.
SUBMIT FORM/DOCUMENTATION TO JANE.

AFTER ALL FORMS ARE SUBMITTED, YOU MAY VIEW EVERYONE'S DOCUMENTATION BY
LOGGING ONTO GOOGLE DOCS. ENTER USER NAME: BESTAHOFFMAN@GMAIL.COM -
PASSWORD: HEPARKS2012 ~ THEY ARE ALSO ON THE DISTRICT'S SHARED DRIVE.

CONFERENCE EDUCATION SUMMARY FORM

IAPD/IPRA CONFERENCE

JANUARY 2017

PROGRAM SESSION NUMBER 111
 TITLE OF SESSION Legal/Legislative Part II
 PRESENTER(S) Andrew Paine - Treasurer IAPD

1. What knowledge/information was of value to you/Hoffman Estates Park District?

Updated case law primarily to
FOIA / open meetings act.

2. Practical applications for HEPD.

- guidance for best practices + timely responses
to FOIA Requests

SUBMITTED BY: ERIC LEWIS

PLEASE FILL IN THIS FORM (OR ONE OF YOUR OWN) FOR EACH SESSION YOU ATTEND. SUBMIT FORM/DOCUMENTATION TO JANE.

AFTER ALL FORMS ARE SUBMITTED, YOU MAY VIEW EVERYONE'S DOCUMENTATION BY LOGGING ONTO GOOGLE DOCS. ENTER USER NAME: BESTAHOFFMAN@GMAIL.COM - PASSWORD: HEPARKS2012 ~ THEY ARE ALSO ON THE DISTRICT'S SHARED DRIVE.

CONFERENCE EDUCATION SUMMARY FORM

IAPD/IPRA CONFERENCE

JANUARY 2017

PROGRAM SESSION NUMBER 106

TITLE OF SESSION NEW FLSA Regulations

PRESENTER(S) Susan Blower / Amadea Collman

1. What knowledge/information was of value to you/Hoffman Estates Park District?

- Updates to recent FLSA exempt (non-exempt salary threshold regulations/norms).
- general review of IL labor law pertaining to breaks, meals, etc.

2. Practical applications for HEPD.

- review/ensure all policies + procedures to ensure HEPD remains in legal compliance.

SUBMITTED BY: ETHEL LEVINGETZ

PLEASE FILL IN THIS FORM (OR ONE OF YOUR OWN) FOR EACH SESSION YOU ATTEND. SUBMIT FORM/DOCUMENTATION TO JANE.

AFTER ALL FORMS ARE SUBMITTED, YOU MAY VIEW EVERYONE'S DOCUMENTATION BY LOGGING ONTO GOOGLE DOCS. ENTER USER NAME: BESTAHOFFMAN@GMAIL.COM - PASSWORD: HEPARKS2012 ~ THEY ARE ALSO ON THE DISTRICT'S SHARED DRIVE.

CONFERENCE EDUCATION SUMMARY FORM

IAPD/IPRA CONFERENCE

JANUARY 2017

PROGRAM SESSION NUMBER # 142 SATURDAY 1/21/17
12:30 - 1:45 p.m.
Topic Track:

TITLE OF SESSION PARK WINS THE NEXT
ENDING STRAY

PRESENTER(S) ROBERT BRUSH SCOTT A. PUMA

1. What knowledge/information was of value to you/Hoffman Estates Park District?
A WIDE RANGE OF "WHAT IF" REAL LIFE SPECIFIC
SCENARIOS WERE DISCUSSED INCLUDING
FOIA ISSUES, OPEN MEETING ACTS VIOLATIONS,
PAC DECISIONS/RECOMMENDATIONS, CONTRACTS,
FIRST AMENDMENT RIGHTS, USE OF SOCIAL MEDIA,
USE OF PRIVATE PHONES AND E-MAILS, ETC.
PAC CAN TAKE ON BOTH PRIVATE OR PUBLIC
DEVICES.

2. Practical applications for HEPD.

- THE PUBLIC ACCESS COUNSELOR (PAC) ISSUES 15/16
FORMAL OPINIONS EVERY YEAR SO IT IS
IMPORTANT TO STAY ON TOP OF THEIR COMMUNICATIONS.
THEIR OPINIONS WEIGH HEAVILY AS ONLY ONE
CHALLENGE HAS BEEN WON AGAINST THEM IN 5 YEARS
- IF AN ITEM IS NOT ON THE AGENDA YOU CANT TAKE
FORMAL ACTION
- ALL CONTRACTS MUST BE APPROVED IN OPEN SESSION.
- PUBLIC COMMENT RULES ARE IMPORTANT AND
SHOULD BE ENFORCED REGULARLY AND CONSISTENTLY

SUBMITTED BY: John J. McAnis 1/24/17

PLEASE FILL IN THIS FORM (OR ONE OF YOUR OWN) FOR EACH SESSION YOU ATTEND.
 SUBMIT FORM/DOCUMENTATION TO JANE.

AFTER ALL FORMS ARE SUBMITTED, YOU MAY VIEW EVERYONE'S DOCUMENTATION BY
 LOGGING ONTO GOOGLE DOCS. ENTER USER NAME: BESTAHOFFMAN@GMAIL.COM -
 PASSWORD: HEPARKS2012 ~ THEY ARE ALSO ON THE DISTRICT'S SHARED DRIVE.

CONFERENCE EDUCATION SUMMARY FORM

IAPD/IPRA CONFERENCE

JANUARY 2017

PROGRAM SESSION NUMBER # 142

TITLE OF SESSION Park Wars - The Newer Ending: Saga

PRESENTER(S) Robert K. Bush - Scott A. Puma

1. What knowledge/information was of value to you/Hoffman Estates Park District?

This session is always good - It deals with actual cases handled by the courts, involving PK Districts, and municipalities - Discussed charges of laws.
Most topics we (PK District) are aware of and handle.

2. Practical applications for HEPD.

- Interesting topic - you can not restrict content of a public comment, but can limit time given to a particular comment.
- Important to have policy for how long a resident can talk and how long a particular topic can be talked about. Add to this, if you have several residents that want to talk on same subject, have policy limiting time on topic
- You can not prohibit residents from criticizing a elected officials.

SUBMITTED BY: RON EVANS - Commissioner

PLEASE FILL IN THIS FORM (OR ONE OF YOUR OWN) FOR EACH SESSION YOU ATTEND.
SUBMIT FORM/DOCUMENTATION TO JANE.

AFTER ALL FORMS ARE SUBMITTED, YOU MAY VIEW EVERYONE'S DOCUMENTATION BY LOGGING ONTO GOOGLE DOCS. ENTER USER NAME: BESTAHOFFMAN@GMAIL.COM - PASSWORD: HEPARKS2012 ~ THEY ARE ALSO ON THE DISTRICT'S SHARED DRIVE.

Hot Topics in Employment

Valuable information:

Addressed recent legislative changes including the proposed minimum salary level for exempt employees (currently on hold) and other topics including unionization and transgender employee guidelines.

Practical applications for HEPD:

Staff has addressed the new salary level requirements already. We have policies and procedures for transgender employees and patrons and will focus on training in the future. The union topic was interesting, as there seems to be a new push in some areas. It is important that the District follow all rules regarding the possible formation of a union very carefully should it present itself.

Legal Legislative Part 1 and Part 2

Valuable information:

Both sessions addressed current and pending legislation and court case law on topics including FOIA, OMA, IMRF, government consolidation, etc.

Practical applications for HEPD:

Staff has been very proactive in these areas with current policies, procedures and training to ensure the District is protected and in compliance with all legal requirements.

Changing Your Agency's culture to reduce tort exposure

Valuable information:

Focused on a variety of training and procedures to help ensure the district maintains a low level of possible legal exposure from bad practices.

Practical applications for HEPD:

Session highlighted how being a member of PDRMA helps a district avoid bad practice liability or legal exposure. Emphasized how good procedures that are properly followed help maintain a district's limited risk exposure.

HR/RISK MANAGEMENT

CONFERENCE EDUCATION SUMMARY FORM

IAPD/IPRA CONFERENCE

JANUARY 2017

085-930
Friday

PROGRAM SESSION NUMBER 314

TITLE OF SESSION Active Threat Emergency preparedness

PRESENTER(S) Paul Timm

1. What knowledge/information was of value to you/Hoffman Estates Park District?

Paul@ActiveSecurity.com
- Social media - Facebook / Twitter - mass notification Village
Key #1 - Collaboration - Top down Commitment - (Start @ the TOP)
- Accountability (N.I.M.S.)
- mass notification

2. Practical applications for HEPD.

Key 2 - awareness (Run-Hide-Fight) L.A. County
Key 3 - involving youth.

SUBMITTED BY: Jane Fong

PLEASE FILL IN THIS FORM (OR ONE OF YOUR OWN) FOR EACH SESSION YOU ATTEND.
SUBMIT FORM/DOCUMENTATION TO JANE.

AFTER ALL FORMS ARE SUBMITTED, YOU MAY VIEW EVERYONE'S DOCUMENTATION BY LOGGING ONTO GOOGLE DOCS. ENTER USER NAME: BESTAHOFFMAN@GMAIL.COM - PASSWORD: HEPARKS2012 ~ THEY ARE ALSO ON THE DISTRICT'S SHARED DRIVE.

CONFERENCE EDUCATION SUMMARY FORM

IAPD/IPRA Conference

JANUARY 2017

PROGRAM SESSION NUMBER _

TITLE OF SESSION **Fraud Risks/Internal Controls**

PRESENTER(S) _____ **James Sullivan Sikich**

1. What knowledge/information was of value to you/Hoffman Estates Park District?

The session spoke to a variety of items that truly are considered as fraud; circumventing rules, asset misappropriation, misuse of time, unwarranted OT, cheating time, ghost invoices, product substitution as examples.

Discussed that having a process for fraud investigation established is just as important as internal controls.

Having consistent discipline in place for violations is key to eliminating and addressing potential fraud.

Discussed stringing payables, breaking up purchases on multiple requisitions/purchase orders to avoid purchasing rules, is fraud as well.

Handout information attached.

SUBMITTED BY: _____ **Lynne Cotshott** _____

**PLEASE FILL IN THIS FORM (OR ONE OF YOUR OWN) FOR EACH SESSION YOU ATTEND.
SUBMIT FORM/DOCUMENTATION TO JANE.**

AFTER ALL FORMS ARE SUBMITTED, YOU MAY VIEW EVERYONE'S DOCUMENTATION BY LOGGING ONTO GOOGLE DOCS. ENTER USER NAME: BESTAHOFFMAN@GMAIL.COM – PASSWORD: HEPARKS2012.

CONFERENCE EDUCATION SUMMARY FORM

IAPD/IPRA CONFERENCE

JANUARY 2017

Code: 2303

PROGRAM SESSION NUMBER 305
TITLE OF SESSION Interviewing for Results
PRESENTER(S) Scott Choramec

1. What knowledge/information was of value to you/Hoffman Estates Park District?

STAR approach

Situation "Tell me about a situation or task."
Task What actions did you take?
Action What result did you get?
Result
drill down for the results

"When was the last time..."

2. Practical applications for HEPD.

See great list of sample questions in Ask your staff handouts.
How are you doing?
How's our progress?
Are there obstacles?
What do you need?
What can I do for you?

1) Take care of your staff
2) Take care of your customers
3) Take care of yourself

SUBMITTED BY: Sandy Manisco

PLEASE FILL IN THIS FORM (OR ONE OF YOUR OWN) FOR EACH SESSION YOU ATTEND.
SUBMIT FORM/DOCUMENTATION TO JANE.

AFTER ALL FORMS ARE SUBMITTED, YOU MAY VIEW EVERYONE'S DOCUMENTATION BY LOGGING ONTO GOOGLE DOCS. ENTER USER NAME: BESTAHOFFMAN@GMAIL.COM - PASSWORD: HEPARKS2012 ~ THEY ARE ALSO ON THE DISTRICT'S SHARED DRIVE.

CONFERENCE EDUCATION SUMMARY FORM

IAPD/IPRA CONFERENCE

JANUARY 2017

PROGRAM SESSION NUMBER # 309

TITLE OF SESSION Managing and Using Drones In Recreational Public Property

PRESENTER(S) Michael Clark - ED Palatine

1. What knowledge/information was of value to you/Hoffman Estates Park District?

- Big difference between Commercial and Resident - Fun use Drones.
- Drones or also known as UAV (Unmanned Aerial Vehicle).
- Governed or regulated primarily by FAA - however loosely -
- common use - Photography, Racing (competitive), Fun, Air shows
- Model Airplane enthusiasts (Modelers) are in decline, Drones probable replacement
- Still not enough regulation, PDRMA not in favor.

2. Practical applications for HEPD.

- Park Districts probably not ready for recreational use areas for Drones. but commercially are looking at their own uses - GIS mapping, photo for Marketing, trouble shooting for roofs and fields.
- Drone zones or no Drone zones, Fly or no Fly - and how do you regulate, some feel you manage like Dog Parks.
- Drone industry is not much help,
- PK Districts should start with policy statement.

SUBMITTED BY: Ron EVANS - Commissioner

PLEASE FILL IN THIS FORM (OR ONE OF YOUR OWN) FOR EACH SESSION YOU ATTEND. SUBMIT FORM/DOCUMENTATION TO JANE.

AFTER ALL FORMS ARE SUBMITTED, YOU MAY VIEW EVERYONE'S DOCUMENTATION BY LOGGING ONTO GOOGLE DOCS. ENTER USER NAME: BESTAHOFFMAN@GMAIL.COM - PASSWORD: HEPARKS2012 ~ THEY ARE ALSO ON THE DISTRICT'S SHARED DRIVE.

131 Marketing & Managing Drone use by Park Districts

Presenter: Derke Price

What knowledge/information was of value to HEPD?

- The use of drones in parks will only increase as technology advances and they become as common as the automobile. Mail is currently delivered by drones in Switzerland. Amazon is currently negotiating with the FAA and testing drone delivery systems. Drones are here to stay. The FAA has published guidelines for commercial drone use but has not put forth anything for the recreational or private use of drones. For all practical and legal purposes, the park district can only enforce its wishes on the surface of the earth and upward for 150 feet above the ground. According to Derke Price, enforcement of the use of the air space above park property would be a legal challenge and costly one should a plaintiff challenge the district in court.
- Derke recommends the district develop places for private drone users to go and fly their devices. Control of commercial operators could be done by park permit. It is recommended that a permit process be developed for commercial drone use over the parks and that way when an occurrence happens we would not have to deny the person or persons that access ability. FAA has set standards for operation which includes not flying over people or private property.
- If the district were to engage in drone operations, we could obtain a 107 Remote Certification Exemptions intended for governmental agencies. However, it would be advantageous to have staff certified as an operator under the normal process.
- From a legal point, enforcement of park ordinances against the use of drones would be legally challenging and if a person does not follow the wishes of the district, the district should then report it to the FAA.

Practical applications for HEPD.

- The District should take a positive approach and facilitate use of drones within the district and not just place a ban. The FAA may or may not help in meeting the district's intent and wishes as it relates to drone use.

Gary Buczkowski IPRA 2017 1-19-1-22-2017

CONFERENCE EDUCATION SUMMARY FORM

IAPD/IPRA CONFERENCE

JANUARY 2017

In Centre program
- referrals
- employee of the month
- uniform
- social
- beamer

from Squads to include

PROGRAM SESSION NUMBER _____

TITLE OF SESSION Tips for Recruiting the Millennial Workforce

PRESENTER(S) Angela Summers

1. What knowledge/information was of value to you/Hoffman Estates Park District?

save eyes
save time
college for
% of where
career

- recruitment planning - work w/ schedule ^{Hurons students athlete}
- technology is a way of life - catch worthy posts ^{we picture of staff & facilities}
- purpose driven
- Adjectives to attract in ads
- focus on the positive staff - rewards
- open dialogue/conversation

2. Practical applications for HEPD.

- Facebook is dead to them • trendy workplace
- demos of posts (statistics)
- Flexibility - unknown relevant for days off - perks
- incorporate parents - valuable & beneficial employee
- career fairs - have food booster staff
- work people are family

SUBMITTED BY: Martha Houston

PLEASE FILL IN THIS FORM (OR ONE OF YOUR OWN) FOR EACH SESSION YOU ATTEND. SUBMIT FORM/DOCUMENTATION TO JANE.

AFTER ALL FORMS ARE SUBMITTED, YOU MAY VIEW EVERYONE'S DOCUMENTATION BY LOGGING ONTO GOOGLE DOCS. ENTER USER NAME: BESTAHOFFMAN@GMAIL.COM - PASSWORD: HEPARKS2012 ~ THEY ARE ALSO ON THE DISTRICT'S SHARED DRIVE.

CONFERENCE EDUCATION SUMMARY FORM

IAPD/IPRA CONFERENCE

JANUARY 2017

PROGRAM SESSION NUMBER 327

TITLE OF SESSION Tips for Recruiting the Millennial Workforce

PRESENTER(S) Angela Summers

1. What knowledge/information was of value to you/Hoffman Estates Park District?

Plan for recruitment - flexibility in schedule, know the audience,
* focus on technology, Have marketing plan - where can the
job lead? They like what's trendy - make fun - add food "exclusive"
* Offer incentives - uniforms, training, sell your business.

2. Practical applications for HEPD.

- offer flexible schedules - Boost them up - focus on positives.
- Look at interview questions: "Who are you?" - open dialog
- Give a little bit.

SUBMITTED BY: Wendy Stoner

PLEASE FILL IN THIS FORM (OR ONE OF YOUR OWN) FOR EACH SESSION YOU ATTEND.
SUBMIT FORM/DOCUMENTATION TO JANE.

AFTER ALL FORMS ARE SUBMITTED, YOU MAY VIEW EVERYONE'S DOCUMENTATION BY
LOGGING ONTO GOOGLE DOCS. ENTER USER NAME: BESTAHOFFMAN@GMAIL.COM -
PASSWORD: HEPARKS2012 ~ THEY ARE ALSO ON THE DISTRICT'S SHARED DRIVE.

LEADERSHIP / MANAGEMENT

CONFERENCE EDUCATION SUMMARY FORM

IAPD/IPRA CONFERENCE

JANUARY 2017

PROGRAM SESSION NUMBER 23

TITLE OF SESSION Building Meaningful Relationships at Work

PRESENTER(S) Angela Summers

1. What knowledge/information was of value to you/Hoffman Estates Park District?

- ^{ASK} learn about coworkers' personal lives (within reason) to create empathy & rapport
- Millennials (or new staff) can learn from veteran staff ~~will~~ to preserve integrity of past experiences, while bringing in fresh ideas

2. Practical applications for HEPD.

- Communicate more with co-workers, team, other departments
- Pair unlikely co-workers (ie; new staff & veteran staff) to create rapport & learn new things

SUBMITTED BY: Colleen Palmer

PLEASE FILL IN THIS FORM (OR ONE OF YOUR OWN) FOR EACH SESSION YOU ATTEND. SUBMIT FORM/DOCUMENTATION TO JANE.

AFTER ALL FORMS ARE SUBMITTED, YOU MAY VIEW EVERYONE'S DOCUMENTATION BY LOGGING ONTO GOOGLE DOCS. ENTER USER NAME: BESTAHOFFMAN@GMAIL.COM - PASSWORD: HEPARKS2012 ~ THEY ARE ALSO ON THE DISTRICT'S SHARED DRIVE.

CONFERENCE EDUCATION SUMMARY FORM

IAPD/IPRA CONFERENCE

JANUARY 2017

PROGRAM SESSION NUMBER 23

TITLE OF SESSION Building Meaningful Relationship AT Work

PRESENTER(S) Angela Summers

1. What knowledge/information was of value to you/Hoffman Estates Park District?

TRUST IS KEY
Relationship
Loyalty

2. Practical applications for HEPD.

HAVING A good Relationship WITH STAFF
~~you~~ your Results will be you HAVE
~~to~~ A Better Employee.

SUBMITTED BY: Bill Feltz

PLEASE FILL IN THIS FORM (OR ONE OF YOUR OWN) FOR EACH SESSION YOU ATTEND.
SUBMIT FORM/DOCUMENTATION TO JANE.

AFTER ALL FORMS ARE SUBMITTED, YOU MAY VIEW EVERYONE'S DOCUMENTATION BY
LOGGING ONTO GOOGLE DOCS. ENTER USER NAME: BESTAHOFFMAN@GMAIL.COM -
PASSWORD: HEPARKS2012 ~ THEY ARE ALSO ON THE DISTRICT'S SHARED DRIVE.

CONFERENCE EDUCATION SUMMARY FORM

35

IAPD/IPRA CONFERENCE

JANUARY 2017

PROGRAM SESSION NUMBER 505

TITLE OF SESSION Communicate for The Win

PRESENTER(S) Lori Klinka

1. What knowledge/information was of value to you/Hoffman Estates Park District?

- Decide what you want to improve
- Focus on the audience (it's all about them) give them what they need & get "buy in" (let them know whats in it for them)
- Use stories - a compelling story consists of
Visual, Feel, hear

2. Practical applications for HEPD.

At staff meetings when explaining a new policy/procedure explain the reasoning & how it will impact the person whether positive or negative

SUBMITTED BY: Debbie

PLEASE FILL IN THIS FORM (OR ONE OF YOUR OWN) FOR EACH SESSION YOU ATTEND.
SUBMIT FORM/DOCUMENTATION TO JANE.

AFTER ALL FORMS ARE SUBMITTED, YOU MAY VIEW EVERYONE'S DOCUMENTATION BY LOGGING ONTO GOOGLE DOCS. ENTER USER NAME: BESTAHOFFMAN@GMAIL.COM - PASSWORD: HEPARKS2012 ~ THEY ARE ALSO ON THE DISTRICT'S SHARED DRIVE.

CONFERENCE EDUCATION SUMMARY FORM

IAPD/IPRA CONFERENCE

JANUARY 2017

PROGRAM SESSION NUMBER 505

TITLE OF SESSION COMMUNICATE FOR THE WIN

PRESENTER(S) LORI KLINCKA

1. What knowledge/information was of value to you/Hoffman Estates Park District?

COMMUNICATE IS NOT AN optional, it
IS CRITICAL FOR ME TO BE SUCCESSFUL.

2. Practical applications for HEPD.

TO BE A BETTER LISTENER. TAKING IN WHAT
STAFF IS TELLING ME AND THEN TRY AND
DO SOMETHING ABOUT IT.

SUBMITTED BY: Bruce Falseth

PLEASE FILL IN THIS FORM (OR ONE OF YOUR OWN) FOR EACH SESSION YOU ATTEND.
SUBMIT FORM/DOCUMENTATION TO JANE.

AFTER ALL FORMS ARE SUBMITTED, YOU MAY VIEW EVERYONE'S DOCUMENTATION BY
LOGGING ONTO GOOGLE DOCS. ENTER USER NAME: BESTAHOFFMAN@GMAIL.COM -
PASSWORD: HEPARKS2012 ~ THEY ARE ALSO ON THE DISTRICT'S SHARED DRIVE.

Dean Bostrom

From: Dean Bostrom
Sent: Monday, January 23, 2017 9:09 AM
To: Dean Bostrom
Subject: Communicating to win #505 Lori Klinka

Speakers are naturally Nervous...focus on self not message or audience. Nervous reaction..lose focus, sweat, heart racing, physicalnervous energy changes form..going to happen...need to be able to control nerves.. Energy is good...need to channel energy excitement to be there in the moment..use what you have energy.. in positive way...when all about message..people think words stand on their own..need to conect words to audience...all about people who you are speaking to..people want you to be real, authenic....connect what do **they** want , need? Give them only what they need, they are thinking what is in it for me?

Performance mindset...judge ourself. Reflect on past communications worry if last was poor...or future...Mastery..evaluation or learning..what worked what did not work? When I started the meeting, what should I do different?

Goals for presentation? Focus 100 on who you are speaking to

Buy in..what is in it for them? Reason for meeting? Attention span...structure what you are going to talk about... Communication..power of pursausion?

Using stories.... very important, emotionally connected, easy to remember....our minds remember what we see, feel, then hear...mind is constantly

Point, story then point.....never give up The little train that kept chugging along.. What makes a good story? Specific details that drive home or connect with everything is not important...

Story of constant change..evolving process..mind boggling...how have we (organization) made a difference? Tell story right away in meeting!

What do employees want? Want to be recognized...

Preparing to speak....write it down..bullet points..need to feel good about it (presentation) impotant to rehearse outloud! Reading is not rehearsing...3 to5 times..not just words, having energy to reach very one in the room. Biggest difference! Not about memorizing ..know opening however look at notes and rehearse...out loud words, energy, focus like riding a bike have to actually do it

30 font 3 points and 3 xxx? visual pictures are great, when slide goes up people are reading and not listening..the more you have the more you lose them...once audience checks outs, difficult to get back

Peraface what next slide is going to be...want to point out....tell what slides means..emotion

What is significance of information...

Q & A....

Repeat the question..time to reflect..do not be afraid of pausing...when in doubt...ask to repeat the question.

Imprompt questions...point story and point....repeat question...then point, story point or two or three points...the first ...the second... and thenthen repeat tell them what you are going to tell them, tell them and tell them what you just told them.

Numbers along do not tell a story or get rezction from audiance ...what you do matters...tell story senior center/off ice project how this going to benefit community...

Elaphant in the room..acknowledge it upfront..as we all know....address it...

Walk aways...focus on audience, practice, practice; getting away from judging self reflect on improving moving forward

not about numbers and dollars....personal impact on individuals. People business! What we do matters

Dean Bostrom, CPRE

Executive Director / Board Secretary

t 847-310-3604 | f 847-885-7523 | e dbostrom@heparks.org

CONFERENCE EDUCATION SUMMARY FORM

IAPD/IPRA CONFERENCE

JANUARY 2017

PROGRAM SESSION NUMBER 21

TITLE OF SESSION Fire It Up! The power of making Good Happen

PRESENTER(S) Lisa Paradis

1. What knowledge/information was of value to you/Hoffman Estates Park District?

- As a leader you create ^{define} the culture,
- Are you there ~~the~~ to "do your job + get a paycheck"
OR are you there to be engaged (teamwork + give back)
Complacency = contentment - Your desire to change
must be greater than your desire to stay the same

2. Practical applications for HEPD.

- Departments need to work together (teamwork)
to move ahead and create a positive culture.

SUBMITTED BY: 

PLEASE FILL IN THIS FORM (OR ONE OF YOUR OWN) FOR EACH SESSION YOU ATTEND.
SUBMIT FORM/DOCUMENTATION TO JANE.

AFTER ALL FORMS ARE SUBMITTED, YOU MAY VIEW EVERYONE'S DOCUMENTATION BY LOGGING ONTO GOOGLE DOCS. ENTER USER NAME: BESTAHOFFMAN@GMAIL.COM - PASSWORD: HEPARKS2012 ~ THEY ARE ALSO ON THE DISTRICT'S SHARED DRIVE.

"It is better to be respected than to be liked."

39

How to be direct:
"Help me to understand"

CONFERENCE EDUCATION SUMMARY FORM

"What I heard ~~we~~ you say was..."

IAPD/IPRA CONFERENCE

"What questions do you have?"

JANUARY 2017

PROGRAM SESSION NUMBER #18

TITLE OF SESSION Game of Thrones

PRESENTER(S) Gail Johnson & Dawn Parr

1. What knowledge/information was of value to you/Hoffman Estates Park District?

① Avoid Assumptions - that everyone is listening - that they understood what we were saying, - or that they know what we know.

② Clarity - be clear with what you say / what you want.

③ Be direct. - Know what you want to say and say it.

2. Practical applications for HEPD.

Ignoring staff is the worst thing you can do.

giving negative feedback is better than getting nothing at all - But it is still awful.

Only positive feedback - makes people feel great - But still doesn't get what you want.

It's not about making them feel good. It's about getting what you want.

SUBMITTED BY: Direct and honest feedback!

PLEASE FILL IN THIS FORM (OR ONE OF YOUR OWN) FOR EACH SESSION YOU ATTEND.
SUBMIT FORM/DOCUMENTATION TO JANE.

AFTER ALL FORMS ARE SUBMITTED, YOU MAY VIEW EVERYONE'S DOCUMENTATION BY LOGGING ONTO GOOGLE DOCS. ENTER USER NAME: BESTAHOFFMAN@GMAIL.COM - PASSWORD: HEPARKS2012 ~ THEY ARE ALSO ON THE DISTRICT'S SHARED DRIVE.

"We are working with people and people are ^{not} let's."

40
Use these phrases -> Help me to understand
- what I heard you say was...
- what questions do you have?

CONFERENCE EDUCATION SUMMARY FORM

IAPD/IPRA CONFERENCE

JANUARY 2017

PROGRAM SESSION NUMBER 18

TITLE OF SESSION Game of Thrones

PRESENTER(S) Gail Johnson & Pam Parr

1. What knowledge/information was of value to you/Hoffman Estates Park District?

- Be direct - know what you want to say + say it.
- ^{of issues} listening staff keeps them disengaged
- Always keep end result as goal
- being critical is demotivating
- always direct / honest feedback will give results

2. Practical applications for HEPD.

- Don't assume people are smart - what you know.
- Always be clear about what is needed & how to achieve it.

SUBMITTED BY: Dulicia

PLEASE FILL IN THIS FORM (OR ONE OF YOUR OWN) FOR EACH SESSION YOU ATTEND.
SUBMIT FORM/DOCUMENTATION TO JANE.

AFTER ALL FORMS ARE SUBMITTED, YOU MAY VIEW EVERYONE'S DOCUMENTATION BY LOGGING ONTO GOOGLE DOCS. ENTER USER NAME: BESTAHOFFMAN@GMAIL.COM - PASSWORD: HEPARKS2012 ~ THEY ARE ALSO ON THE DISTRICT'S SHARED DRIVE.

CONFERENCE EDUCATION SUMMARY FORM

IAPD/IPRA CONFERENCE

JANUARY 2017

PROGRAM SESSION NUMBER 26

TITLE OF SESSION iLearn 2017: Trending Topics

PRESENTER(S) Various Leadership Academy participants

1. What knowledge/information was of value to you/Hoffman Estates Park District?

3 topics ① Using Data for Programming - discussed various ideas on how to collect & use info collected

② Drones in our Parks - discussed laws related to Drones & gave sample policies & registration forms

③ Affiliate Agreements - best practices on creating affiliate agreements

2. Practical applications for HEPD.

① Ideas for gathering data at facilities, programs, events - tablets, social media, idea drop box on website

② Drones - laws are still vague, so make sure policy is

SUBMITTED BY: Colleen

PLEASE FILL IN THIS FORM (OR ONE OF YOUR OWN) FOR EACH SESSION YOU ATTEND. SUBMIT FORM/DOCUMENTATION TO JANE.

AFTER ALL FORMS ARE SUBMITTED, YOU MAY VIEW EVERYONE'S DOCUMENTATION BY LOGGING ONTO GOOGLE DOCS. ENTER USER NAME: BESTAHOFFMAN@GMAIL.COM - PASSWORD: HEPARKS2012 ~ THEY ARE ALSO ON THE DISTRICT'S SHARED DRIVE.

CONFERENCE EDUCATION SUMMARY FORM

IAPD/IPRA CONFERENCE

JANUARY 2017

PROGRAM SESSION NUMBER #27 Sat 1/21 2-3:15pm

TITLE OF SESSION IPRA member Engagement Town Hall

PRESENTER(S) Debbie Trueblood & Rita Fletcher

1. What knowledge/information was of value to you/Hoffman Estates Park District?

This session provided an update regarding the IPRA and provided numerous ideas related to increasing involvement within the IPRA. Information was provided regarding educational, networking, & professional growth opportunities

2. Practical applications for HEPD.

Provided current status & direction, along with involvement opportunities, related to the IPRA. Future direction was also discussed. The information provided supported the importance & value for park district team members to become involved in the IPRA.

SUBMITTED BY: Katie Basile

PLEASE FILL IN THIS FORM (OR ONE OF YOUR OWN) FOR EACH SESSION YOU ATTEND. SUBMIT FORM/DOCUMENTATION TO JANE.

AFTER ALL FORMS ARE SUBMITTED, YOU MAY VIEW EVERYONE'S DOCUMENTATION BY LOGGING ONTO GOOGLE DOCS. ENTER USER NAME: BESTAHOFFMAN@GMAIL.COM - PASSWORD: HEPARKS2012 ~ THEY ARE ALSO ON THE DISTRICT'S SHARED DRIVE.

CONFERENCE EDUCATION SUMMARY FORM

IAPD/IPRA CONFERENCE

JANUARY 2017

PROGRAM SESSION NUMBER #113

TITLE OF SESSION Leadership Development - Maximizing Your Potential

PRESENTER(S) Ed Molitor

1. What knowledge/information was of value to you/Hoffman Estates Park District?

get outside of your comfort zone but work within your strength. It's good to feel nervous and challenged.

Holds input bucket

- choices that limit you - if you make a bad choice - own it. - Impatience w/ the process; take time to figure things out. - If you're not willing to work for it - you're not going to have it.

2. Practical applications for HEPD.

Think outside the box and get creative.

Self ^{core} discipline - leads to self control - leads to self confidence - self realization.

SUBMITTED BY: Jody

PLEASE FILL IN THIS FORM (OR ONE OF YOUR OWN) FOR EACH SESSION YOU ATTEND. SUBMIT FORM/DOCUMENTATION TO JANE.

AFTER ALL FORMS ARE SUBMITTED, YOU MAY VIEW EVERYONE'S DOCUMENTATION BY LOGGING ONTO GOOGLE DOCS. ENTER USER NAME: BESTAHOFFMAN@GMAIL.COM - PASSWORD: HEPARKS2012 ~ THEY ARE ALSO ON THE DISTRICT'S SHARED DRIVE.

CONFERENCE EDUCATION SUMMARY FORM

44

IAPD/IPRA CONFERENCE

JANUARY 2017

PROGRAM SESSION NUMBER 113

TITLE OF SESSION LEADERSHIP DEVELOPMENT - MAXIMIZING YOUR POTENTIAL

PRESENTER(S) ED MOLITOR

1. What knowledge/information was of value to you/Hoffman Estates Park District?

TO FORM A GOOD RELATIONSHIP AND WITH A
GREAT ATTITUDE

2. Practical applications for HEPD.

TO FOCUS ON VISION AND GROWING TOGETHER
AS A TEAM.

SUBMITTED BY: BILL FALCETTI

PLEASE FILL IN THIS FORM (OR ONE OF YOUR OWN) FOR EACH SESSION YOU ATTEND.
SUBMIT FORM/DOCUMENTATION TO JANE.

AFTER ALL FORMS ARE SUBMITTED, YOU MAY VIEW EVERYONE'S DOCUMENTATION BY
LOGGING ONTO GOOGLE DOCS. ENTER USER NAME: BESTAHOFFMAN@GMAIL.COM -
PASSWORD: HEPARKS2012 ~ THEY ARE ALSO ON THE DISTRICT'S SHARED DRIVE.

Maximizing your Potential

January 20, 2016



THE **MOLITOR** GROUP



Sense of Purpose

1. Why are you here?
2. What do you hope to accomplish?
3. If you are skeptical, why?
4. What are you excited about?
5. What is causing you the most anxiety right now?
6. What is holding you back and what push are you feeling?



THE MOLITOR GROUP

Knowing Yourself

Greatest Strengths

- 1.
- 2.
- 3.
- 4.

Weaknesses

- 1.
- 2.
- 3.



THE MOLITOR GROUP

Your Why

your contribution



To

so that

your impact ↗

your contribution



To

so that

your impact ↗

your contribution



To

so that

your impact ↗



THE MOLITOR GROUP

Core Values

Adaptability	Diversity		
Advancement	Education	Inspiration	
Advocacy	Efficiency	Integrity	Respect
Authenticity	Excellence	Invention	Responsibility
Caring	Expertise	Justice	Safety
Change	Flexibility	Leadership	Success
Challenge	Generosity	Legislation	Sustainability
Collaboration	Governance	Loyalty	Teamwork
Commitment	Growth	Pasion	Uniqueness
Communication	Humility	Positivity	Creativity
Community	Compassion	Professionalism	Quality

Roles

1. _____
2. _____
3. _____
4. _____
5. _____

Control

Vision *— [Handwritten Signature]*

Thought of the day: _____



Date: _____

THE MOLITOR GROUP
PRACTICE PLAN

Hours	Activity	Rank	Game Changers
5:00 AM			<input type="checkbox"/>
5:30 AM			<input type="checkbox"/>
6:00 AM			<input type="checkbox"/>
6:30 AM			<input type="checkbox"/>
7:00 AM			<input type="checkbox"/>
7:30 AM			<input type="checkbox"/>
8:00 AM			Quick Hitter
8:30 AM			<input type="checkbox"/>
9:00 AM			<input type="checkbox"/>
9:30 AM			<input type="checkbox"/>
10:00 AM			<input type="checkbox"/>
10:30 AM			<input type="checkbox"/>
11:00 AM			<input type="checkbox"/>
11:30 AM			Drill Work
12:00 PM			<input type="checkbox"/>
12:30 PM			<input type="checkbox"/>
1:00 PM			<input type="checkbox"/>
1:30 PM			<input type="checkbox"/>
2:00 PM			<input type="checkbox"/>
2:30 PM			<input type="checkbox"/>
3:00 PM			<input type="checkbox"/>
3:30 PM			Conditioning
4:00 PM			<input type="checkbox"/>
4:30 PM			<input type="checkbox"/>
5:00 PM			<input type="checkbox"/>
5:30 PM			<input type="checkbox"/>
6:00 PM			<input type="checkbox"/>
6:30 PM			<input type="checkbox"/>
7:00 PM			<input type="checkbox"/>
7:30 PM			<input type="checkbox"/>
8:00 PM			Notes
8:30 PM			
9:00 PM			
9:30 PM			
10:00 PM			

CONFERENCE EDUCATION SUMMARY FORM

IAPD/IPRA CONFERENCE

JANUARY 2017

PROGRAM SESSION NUMBER #113

TITLE OF SESSION Leadership; Maximizing Potential

PRESENTER(S) Ed molitor

1. What knowledge/information was of value to you/Hoffman Estates Park District?

As a leader, one needs to know their sense of purpose - understand what one hopes to accomplish & focus on utilizing ones strengths. The concept of "the golden circle" was discussed - working on your "why" which is in the center of the circle, driving your purpose & sense of direction.

2. Practical applications for HEPD.

Application would be to potentially have this speaker out to the park district. Interesting presentation regarding the use of ones strength & knowing purpose & core values to guide leadership direction & maximize potential

SUBMITTED BY: Kate Basile

PLEASE FILL IN THIS FORM (OR ONE OF YOUR OWN) FOR EACH SESSION YOU ATTEND. SUBMIT FORM/DOCUMENTATION TO JANE.

AFTER ALL FORMS ARE SUBMITTED, YOU MAY VIEW EVERYONE'S DOCUMENTATION BY LOGGING ONTO GOOGLE DOCS. ENTER USER NAME: BESTAHOFFMAN@GMAIL.COM - PASSWORD: HEPARKS2012 ~ THEY ARE ALSO ON THE DISTRICT'S SHARED DRIVE.

CONFERENCE EDUCATION SUMMARY FORM

IAPD/IPRA CONFERENCE

JANUARY 2017

PROGRAM SESSION NUMBER 22

TITLE OF SESSION Moving from Management to Transformational Leadership

PRESENTER(S) _____

1. What knowledge/information was of value to you/Hoffman Estates Park District?

- Types of leadership styles include Participative, Authoritarian, Laissez-faire, & Servant - all are useful in different situations
- Leaders directly impact engagement by inspiring commitment, providing vision, growth & development opportunities, and providing recognition

2. Practical applications for HEPD.

- Use different types of Leadership in different situations to gain ideal employee engagement
- When implementing a new idea, tie it to existing vision, set goals for it, create an action plan & monitor it's progress to the end
- Celebrate successes along the way!

SUBMITTED BY: Colleen Palmer

PLEASE FILL IN THIS FORM (OR ONE OF YOUR OWN) FOR EACH SESSION YOU ATTEND. SUBMIT FORM/DOCUMENTATION TO JANE.

AFTER ALL FORMS ARE SUBMITTED, YOU MAY VIEW EVERYONE'S DOCUMENTATION BY LOGGING ONTO GOOGLE DOCS. ENTER USER NAME: BESTAHOFFMAN@GMAIL.COM - PASSWORD: HEPARKS2012 ~ THEY ARE ALSO ON THE DISTRICT'S SHARED DRIVE.

121

CONFERENCE EDUCATION SUMMARY FORM

IAPD/IPRA CONFERENCE

JANUARY 2017

PROGRAM SESSION NUMBER 24

TITLE OF SESSION Next Level Data

PRESENTER(S) Bobbi Nance PD of Oak Park, Ed Krafcik, Soofa

1. What knowledge/information was of value to you/Hoffman Estates Park District? 634143

Recreation Results com - Bobbi Nance's blog
People respond better to faces with emotion
Netflix collects data + uses to develop content
Data points available to us: Prog time + day, # of days, types,
Advance prog vs. drop in, how they sign up, How \$ they spend

2. Practical applications for HEPD.

Possible data sources we can use:
NOAA (weather), Google trends, Census,
Customer Comments, ESRI
Soofa units can measure park usage

SUBMITTED BY: Sandy Manisio

PLEASE FILL IN THIS FORM (OR ONE OF YOUR OWN) FOR EACH SESSION YOU ATTEND.
SUBMIT FORM/DOCUMENTATION TO JANE.

AFTER ALL FORMS ARE SUBMITTED, YOU MAY VIEW EVERYONE'S DOCUMENTATION BY
LOGGING ONTO GOOGLE DOCS. ENTER USER NAME: BESTAHOFFMAN@GMAIL.COM -
PASSWORD: HEPARKS2012 ~ THEY ARE ALSO ON THE DISTRICT'S SHARED DRIVE.

CONFERENCE EDUCATION SUMMARY FORM

IAPD/IPRA CONFERENCE

JANUARY 2017

PROGRAM SESSION NUMBER 24

TITLE OF SESSION Next Level Data

PRESENTER(S) Bobbi Nance & Ed Krafcik

1. What knowledge/information was of value to you/Hoffman Estates Park District?

◦ Learned more about the numerous types of data that can be collected and how to use it

◦ Various website for data collection ^{& analysis} - Google Trends, EPA ETSSCREEN, Soofa

2. Practical applications for HEPD.

◦ Ask more questions with reference to data

◦ Change way of new program ideas - examine past records/data, then design program around that

◦ Share cross-departmental data to improve offerings across the board

SUBMITTED BY: Colleen Palmer

PLEASE FILL IN THIS FORM (OR ONE OF YOUR OWN) FOR EACH SESSION YOU ATTEND. SUBMIT FORM/DOCUMENTATION TO JANE.

AFTER ALL FORMS ARE SUBMITTED, YOU MAY VIEW EVERYONE'S DOCUMENTATION BY LOGGING ONTO GOOGLE DOCS. ENTER USER NAME: BESTAHOFFMAN@GMAIL.COM - PASSWORD: HEPARKS2012 ~ THEY ARE ALSO ON THE DISTRICT'S SHARED DRIVE.

CONFERENCE EDUCATION SUMMARY FORM

IAPD/IPRA CONFERENCE

JANUARY 2017

PROGRAM SESSION NUMBER #24

TITLE OF SESSION Next ~~Data~~ Level Data

PRESENTER(S) Ed Krafcik, SOOFA; Bobbie Nance, Oak Park Park District

1. What knowledge/information was of value to you/Hoffman Estates Park District?

How data can help in decision making process
Different sources where data can be collected
Dash board program registrations (Rec Trace) track
against market efforts - evaluate degree of success or
failure of particular strategy.

2. Practical applications for HEPD.

Utilize existing Rec Trace data to develop target
market strategies
Google trends - monitor to see what are latest trends
that apply to parks + recreation
Collect wifi data - patterns of social media use - where/what
most popular sites are

SUBMITTED BY: Dean Bestrom

PLEASE FILL IN THIS FORM (OR ONE OF YOUR OWN) FOR EACH SESSION YOU ATTEND.
SUBMIT FORM/DOCUMENTATION TO JANE.

AFTER ALL FORMS ARE SUBMITTED, YOU MAY VIEW EVERYONE'S DOCUMENTATION BY
LOGGING ONTO GOOGLE DOCS. ENTER USER NAME: BESTAHOFFMAN@GMAIL.COM -
PASSWORD: HEPARKS2012 ~ THEY ARE ALSO ON THE DISTRICT'S SHARED DRIVE.

Dean Bostrom

From: Dean Bostrom
Sent: Monday, January 23, 2017 9:09 AM
To: Dean Bostrom
Subject: Next level data #24 Ed Krafcik SOOFA, Bobbie Nance, Oak Park

NetFlix...

Need to ask right questions...we already when, which types of programs, who how far willing to travel, \$ willing to spend, how they register? how they find out ...target marketing...Examine what are your most popular types of programs, when to offer, Being proactive vs reactive...base decisions on data you already have.. Recreation registration data..

We all have problems data can help solve....

Data we can use....

NOAA Weather history...

Google trends...regions...what is most popular i.e. Fitness programs...based on search data

Customer comments...yelp...search what words they use to brand a facility, what is great about it....

Us Census Bureau

EPA EJS screen...environmental, social factors within community where low income use it

GIS..demographic ESRI ARCGIS online..add layers

\$ 500 ESRI Community or Business Analyst...pick qualifications ...where do the...

Own data who are we serving in community age, if kids not involved in pd by age 11 probably will not ...parents need to markets separately

Dash board program registrations & marketing efforts...track marketing efforts

Future data...Big Belly Trash Compactors..beacon to collect data

Place meter..camera feed measure existing park usage patterns

Public WIFI..collect data...Ruckus wireless service

Identify patterns of network use and information about users what social networks are people using

SOOFA ..solar powered smart urban furniture,

Capture information from cell phones..through internet being turned on counting # of people..time stamps ip address..traffic patterns

Dean Bostrom, CPRE

Executive Director / Board Secretary

t 847-310-3604 | f 847-885-7523 | e dbostrom@heparks.org

24 Next Level Data

Presenter: Bobbie Nance / Ed Krafcik

What knowledge/ information was of value to HEPD?

Practical applications for HEPD.

As the pace of change continues to accelerate, the use of data in the decision making process is becoming more important. Changing trends verses being at the cutting edge of trends is what will truly distinguish a top notch organization. Understanding your customer and how and why they are thinking in a certain way is key to data collection.

Data points: where is your customer? How often they do something similar?

- I.e. Shows people watch/ tell a lot about how one’s thinking, and what is of interest to them.
- Need to link different data point to get a more clear or precise picture.

How you use data?

Responding to reports “ life ring”

Using data analytics “ Life preserver”

Some recommended simple sources of data:

NOAA, Google Trends, ARCH GIS, US census, EPA, ESRI community Analyst
good source if you are using GIS \$500/yr

Soffa Tracking device that has been built into a bench to collect a set of point for a particular location. The source is WI Fi use in that particular vicinity. The software has been written to predict base on the sampling, how many potential users have visited a location without actually counting each user.

If you understand your customer you can then market yourself as relevant.

Gary Buczkowski IPRA 2015 1-23-1-25-2015

CONFERENCE EDUCATION SUMMARY FORM

IAPD/IPRA CONFERENCE

JANUARY 2017

PROGRAM SESSION NUMBER 109

TITLE OF SESSION Using Survey Research to Improve Operations

PRESENTER(S) John Curran, Tinley Park PD + Karol Komar, Tinley Park PD

1. What knowledge/information was of value to you/Hoffman Estates Park District?

Use research to decide what you should do, not to reinforce plans in existence

2. Practical applications for HEPD.

Session was about how to conduct an Attitude + Int. Survey, & reviewed the results Tinley Park PD got.

SUBMITTED BY: Sandy Maniso

PLEASE FILL IN THIS FORM (OR ONE OF YOUR OWN) FOR EACH SESSION YOU ATTEND. SUBMIT FORM/DOCUMENTATION TO JANE.

AFTER ALL FORMS ARE SUBMITTED, YOU MAY VIEW EVERYONE'S DOCUMENTATION BY LOGGING ONTO GOOGLE DOCS. ENTER USER NAME: BESTAHOFFMAN@GMAIL.COM - PASSWORD: HEPARKS2012 ~ THEY ARE ALSO ON THE DISTRICT'S SHARED DRIVE.

CONFERENCE EDUCATION SUMMARY FORM

IAPD/IPRA CONFERENCE

JANUARY 2017

PROGRAM SESSION NUMBER 109

TITLE OF SESSION Using Survey Research to Improve Your Operation

PRESENTER(S) John Curran & Karol Komar

1. What knowledge/information was of value to you/Hoffman Estates Park District?

- Independent Consultants are the experts on survey research & carry more validity when sharing results with community
- There are various things to consider when hiring a consultant & doing the survey, including cost, process, questions asked, result categories, etc.
- Ask more questions about negative results or results you didn't expect

2. Practical applications for HEPD.

- When doing a survey, hire independent consultant - results shouldn't come from your agency
- ~~Will~~ Create a results matrix - from there, identify negative results & do more research, ask questions of specific group, to assess their needs

SUBMITTED BY: Wileen Palmer

PLEASE FILL IN THIS FORM (OR ONE OF YOUR OWN) FOR EACH SESSION YOU ATTEND. SUBMIT FORM/DOCUMENTATION TO JANE.

AFTER ALL FORMS ARE SUBMITTED, YOU MAY VIEW EVERYONE'S DOCUMENTATION BY LOGGING ONTO GOOGLE DOCS. ENTER USER NAME: BESTAHOFFMAN@GMAIL.COM - PASSWORD: HEPARKS2012 ~ THEY ARE ALSO ON THE DISTRICT'S SHARED DRIVE.

CONFERENCE EDUCATION SUMMARY FORM

IAPD/IPRA CONFERENCE

JANUARY 2017

June 2017
Tinley Park PD

PROGRAM SESSION NUMBER 109

TITLE OF SESSION Using survey research to improve your operation

PRESENTER(S) John Curran, Karol Komar
Tinley Park - PD

1. What knowledge/information was of value to you/Hoffman Estates Park District?

- Why is your agency running a survey?
- Results by age group
- Benchmarking - comparing PDs in IL & National
- Rate service - rate level of satisfaction
- Limit the time the individual spends taking survey

2. Practical applications for HEPD. -

- ~~XXXXXX~~ Satisfaction Assessment Matrix

SUBMITTED BY: Walter Houston

PLEASE FILL IN THIS FORM (OR ONE OF YOUR OWN) FOR EACH SESSION YOU ATTEND.
SUBMIT FORM/DOCUMENTATION TO JANE.

AFTER ALL FORMS ARE SUBMITTED, YOU MAY VIEW EVERYONE'S DOCUMENTATION BY LOGGING ONTO GOOGLE DOCS. ENTER USER NAME: BESTAHOFFMAN@GMAIL.COM - PASSWORD: HEPARKS2012 ~ THEY ARE ALSO ON THE DISTRICT'S SHARED DRIVE.

MARKETING/ COMMUNICATIONS

CONFERENCE EDUCATION SUMMARY FORM

IAPD/IPRA CONFERENCE

JANUARY 2017

PROGRAM SESSION NUMBER #905 1/21/2017 10:15am to 11:30am

TITLE OF SESSION Customer Service Boot Camp: Back to the Basics

PRESENTER(S) Annie & Iris, Minneapolis Park & Rec

1. What knowledge/information was of value to you/Hoffman Estates Park District?

Internal Staff are also customers. Communicating with your colleagues is vital to ensure that
our customer service level provided to our patrons stays high. i.e. a patron asks information
about a program. Last minute changes need to be communicated to pertinent staff so the correct
data is given to the patron. Understanding our demographic users, the different cultures and
nationalities that we serve. High energy level, good attitude, friendly demeanor, "Please" &
"Thank you" are the two most important words in Customer service.

2. Practical applications for HEPD.

We have a similar initiative already with our CHEER program. Annie & Iris said they developed
a system in which they created a Powerpoint presentation and recorded their voices to go over
the slides presented. They were able to created handouts and dvds with these included and handed
them out to new employees as they were hired. Part of the new hire packet is their training for
excellent Customer Service.

SUBMITTED BY: John Agudelo

**PLEASE FILL IN THIS FORM (OR ONE OF YOUR OWN) FOR EACH SESSION YOU ATTEND.
SUBMIT FORM/DOCUMENTATION TO JANE.**

**AFTER ALL FORMS ARE SUBMITTED, YOU MAY VIEW EVERYONE'S DOCUMENTATION BY
LOGGING ONTO GOOGLE DOCS. ENTER USER NAME: BESTAHOFFMAN@GMAIL.COM -
PASSWORD: HEPARKS2012 ~ THEY ARE ALSO ON THE DISTRICT'S SHARED DRIVE.**

CONFERENCE EDUCATION SUMMARY FORM

IAPD/IPRA CONFERENCE

JANUARY 2017

PROGRAM SESSION NUMBER 905

TITLE OF SESSION Custom Service Boot Camp

PRESENTER(S) Annex Olson & 1015 Publishing Pictured

1. What knowledge/information was of value to you/Hoffman Estates Park District?

- * Fish video - focus on Fun!
- * BE THERE / Play / make sure my / Have a positive attitude
- * proper phone answering - "please & thank you"
- * No cell phone use @ district

2. Practical applications for HEPD.

- * Staff newsletters monthly?
- * No bags - use @ meetings - way to get to know each other better.
- * Enhance facility appearance.

SUBMITTED BY: [Signature]

PLEASE FILL IN THIS FORM (OR ONE OF YOUR OWN) FOR EACH SESSION YOU ATTEND. SUBMIT FORM/DOCUMENTATION TO JANE.

AFTER ALL FORMS ARE SUBMITTED, YOU MAY VIEW EVERYONE'S DOCUMENTATION BY LOGGING ONTO GOOGLE DOCS. ENTER USER NAME: BESTAHOFFMAN@GMAIL.COM - PASSWORD: HEPARKS2012 ~ THEY ARE ALSO ON THE DISTRICT'S SHARED DRIVE.

CONFERENCE EDUCATION SUMMARY FORM

IAPD/IPRA CONFERENCE

JANUARY 2017

PROGRAM SESSION NUMBER 133

TITLE OF SESSION Invasive Species of the Human Variety

PRESENTER(S) Jamie Johannsen, Moira Meyers, Wendy Kummer

1. What knowledge/information was of value to you/Hoffman Estates Park District?

The presenter gave an interesting approach to viewing our various park users by breaking them down into 3 basic categories. But what was more relevant was how to approach and engage these users through various programs, marketing channels and directives.

2. Practical applications for HEPD.

A concept was presented to involve the community more in natural area management and by doing so educating them on the importance of native plant species and habitat. Instead of arguing with our neighbors over encroachments maybe we should involve them more in habitat management and restoration.

SUBMITTED BY: Steve Bossette

PLEASE FILL IN THIS FORM (OR ONE OF YOUR OWN) FOR EACH SESSION YOU ATTEND. SUBMIT FORM/DOCUMENTATION TO JANE.

AFTER ALL FORMS ARE SUBMITTED, YOU MAY VIEW EVERYONE'S DOCUMENTATION BY LOGGING ONTO GOOGLE DOCS. ENTER USER NAME: BESTAHOFFMAN@GMAIL.COM - PASSWORD: HEPARKS2012 ~ THEY ARE ALSO ON THE DISTRICT'S SHARED DRIVE.

CONFERENCE EDUCATION SUMMARY FORM

IAPD/IPRA CONFERENCE

JANUARY 2017

PROGRAM SESSION NUMBER 17

TITLE OF SESSION Resume Writing and Interview Tips

PRESENTER(S) Tony Oligney - Estill

1. What knowledge/information was of value to you/Hoffman Estates Park District?

Remember you're interviewing everyone, everyday,
every interaction. Make sure people follow directions
"list 3 references" they give 5... they aren't
following directions. Its important to look for
typos, formatting. Leave out objective in resume.

2. Practical applications for ~~HEPD~~ HE Parks

When looking for applicants, make sure they are
able to follow directions, its an indicator of their
attention to detail. Who to mail it to, # of references etc.
Pay attention to skills, are they tailor picked for
this job or generic?

SUBMITTED BY: Lindsay Grace

PLEASE FILL IN THIS FORM (OR ONE OF YOUR OWN) FOR EACH SESSION YOU ATTEND.
SUBMIT FORM/DOCUMENTATION TO JANE.

AFTER ALL FORMS ARE SUBMITTED, YOU MAY VIEW EVERYONE'S DOCUMENTATION BY
LOGGING ONTO GOOGLE DOCS. ENTER USER NAME: BESTAHOFFMAN@GMAIL.COM -
PASSWORD: HEPARKS2012 ~ THEY ARE ALSO ON THE DISTRICT'S SHARED DRIVE.

CONFERENCE EDUCATION SUMMARY FORM

IAPD/IPRA CONFERENCE

JANUARY 2017

PROGRAM SESSION NUMBER 911

TITLE OF SESSION Tailoring your Public Process: Engage your Community

PRESENTER(S) Jeff King and Lindsey Peckinpugh

1. What knowledge/information was of value to you/Hoffman Estates Park District?

Public Process: establish rules of engagement, create a work plan, communicate vision. Get statistical evidence for each project, (demographic primary and secondary) what do you already know about the communities needs based on surveys and use of facilities.

2. Practical applications for ~~HEPD~~ HE Parks

Don't wait to talk to community until you have a project, speak to them along the way. Teen Centers - don't call them that if you expect them to come. Disguise it as a coffee bar, provide food and wifi during late hours.

SUBMITTED BY: Lindsay Grace

PLEASE FILL IN THIS FORM (OR ONE OF YOUR OWN) FOR EACH SESSION YOU ATTEND. SUBMIT FORM/DOCUMENTATION TO JANE.

AFTER ALL FORMS ARE SUBMITTED, YOU MAY VIEW EVERYONE'S DOCUMENTATION BY LOGGING ONTO GOOGLE DOCS. ENTER USER NAME: BESTAHOFFMAN@GMAIL.COM - PASSWORD: HEPARKS2012 ~ THEY ARE ALSO ON THE DISTRICT'S SHARED DRIVE.

CONFERENCE EDUCATION SUMMARY FORM

IAPD/IPRA CONFERENCE

JANUARY 2017

PROGRAM SESSION NUMBER 906

TITLE OF SESSION Throw out the Brochure - Modern Web Marketing

PRESENTER(S) John Klein, Brent Levy, John Reitz

1. What knowledge/information was of value to you/Hoffman Estates Park District?

There are over 3 billion internet users, mobile is
more popular than desktop. Engagement both online
and in person is the gravity that holds your audience around
your brand and gain loyalty. The only constant in web design
is change. Almost 50% of internet users, use chrome
browser

2. Practical applications for ~~HEPD~~ HE Parks

If your website is more than 3 years old, its behind
the times. Dedicated time and money into front and
back end updates keeps from costly overhauls later.
Think about getting everyone involved, like having the
director have a twitter account, having 1 person update the
website is the best way to let it get out of date.

SUBMITTED BY: Lindsay Grace

PLEASE FILL IN THIS FORM (OR ONE OF YOUR OWN) FOR EACH SESSION YOU ATTEND.
SUBMIT FORM/DOCUMENTATION TO JANE.

AFTER ALL FORMS ARE SUBMITTED, YOU MAY VIEW EVERYONE'S DOCUMENTATION BY
LOGGING ONTO GOOGLE DOCS. ENTER USER NAME: BESTAHOFFMAN@GMAIL.COM -
PASSWORD: HEPARKS2012 ~ THEY ARE ALSO ON THE DISTRICT'S SHARED DRIVE.

CONFERENCE EDUCATION SUMMARY FORM

IAPD/IPRA CONFERENCE

JANUARY 2017

PROGRAM SESSION NUMBER 907

TITLE OF SESSION Using Signage and Graphics to Promote Your Brand

PRESENTER(S) Jeff Miller

1. What knowledge/information was of value to you/Hoffman Estates Park District?

Think outside the box. Outdoor, floor, wall
decals/wraps as opposed to banners. Stay consistent
fonts, colors, logos etc. Use space that you
may have forgotten for a logo or "find your way"
signage. New optically clear vinyl for windows/glass.

2. Practical applications for ~~HEPD~~ HE Parks

Wall wraps that work on brick, decorate
large hallways in TC. Floor decals
for major events at TC or in gym.
"frosted" glass for light and privacy at PSSUC.

SUBMITTED BY: Lindsay Grace

PLEASE FILL IN THIS FORM (OR ONE OF YOUR OWN) FOR EACH SESSION YOU ATTEND.
SUBMIT FORM/DOCUMENTATION TO JANE.

AFTER ALL FORMS ARE SUBMITTED, YOU MAY VIEW EVERYONE'S DOCUMENTATION BY
LOGGING ONTO GOOGLE DOCS. ENTER USER NAME: BESTAHOFFMAN@GMAIL.COM -
PASSWORD: HEPARKS2012 ~ THEY ARE ALSO ON THE DISTRICT'S SHARED DRIVE.

PARKS/NATURAL RESOURCES

61

CONFERENCE EDUCATION SUMMARY FORM

IAPD/IPRA CONFERENCE

JANUARY 2017

PROGRAM SESSION NUMBER #210, Sat 10:15am - 11:30am

TITLE OF SESSION Bid process in Plain English

PRESENTER(S) Derek Solberg

1. What knowledge/information was of value to you/Hoffman Estates Park District?

Provided the breakdown & details of the bid process, applicable to larger capital projects exceeding \$25,000. Provided full process & examples of projects completed at various park districts. Provided resources as well.

2. Practical applications for HEPD.

Provided the details and logistics of the bid process - guidelines, appropriate process & documentation. Practical application: confirmation of HEPD process

SUBMITTED BY: Kate Basile

PLEASE FILL IN THIS FORM (OR ONE OF YOUR OWN) FOR EACH SESSION YOU ATTEND.
SUBMIT FORM/DOCUMENTATION TO JANE.

AFTER ALL FORMS ARE SUBMITTED, YOU MAY VIEW EVERYONE'S DOCUMENTATION BY LOGGING ONTO GOOGLE DOCS. ENTER USER NAME: BESTAHOFFMAN@GMAIL.COM - PASSWORD: HEPARKS2012 ~ THEY ARE ALSO ON THE DISTRICT'S SHARED DRIVE.

CONFERENCE EDUCATION SUMMARY FORM

IAPD/IPRA CONFERENCE

JANUARY 2017

PROGRAM SESSION NUMBER 220

TITLE OF SESSION Capital Projects - Approaches for Improving Efficiency & Success

PRESENTER(S) Shane Hamilton, Robert Isoms, Jim Reuter

1. What knowledge/information was of value to you/Hoffman Estates Park District?

The most valuable information taken away from this session was the developmental process and application of capital projects within a park district. Speakers discussed steps taken from designing and fundraising to implementation as well as all the obstacles in between.

2. Practical applications for HEPD.

One notion that really resonated within me was the concept of involving every possible stakeholder in capital projects from those who will fund and maintain it, all the way to the end user. A great example given was allowing children to pick colors for a new playground.

SUBMITTED BY: Steve Bessette

PLEASE FILL IN THIS FORM (OR ONE OF YOUR OWN) FOR EACH SESSION YOU ATTEND. SUBMIT FORM/DOCUMENTATION TO JANE.

AFTER ALL FORMS ARE SUBMITTED, YOU MAY VIEW EVERYONE'S DOCUMENTATION BY LOGGING ONTO GOOGLE DOCS. ENTER USER NAME: BESTAHOFFMAN@GMAIL.COM - PASSWORD: HEPARKS2012 ~ THEY ARE ALSO ON THE DISTRICT'S SHARED DRIVE.

217 3D Trees a new view of maximizing tree benefits

Presenter: Phil Graf /Steve Lane

What knowledge/ information were of value to HEPD?

- Parks and recreation agencies market themselves as the keepers of open space and the natural environment within ones community. However in most cases that effort falls short of actually having as much of an effect on the green environment as one would think. Many efforts to plant tree send with the planting of the trees themselves. When it comes to nurturing and caring for trees many agencies allow nature to do its own thing.
- The potential life cycle of a tree in general should be 100-150 years. Realistically expectation in the urban forest would result in less than 2% every making that expectation. In the Chicago land area the average tree life span has been calculated at less than 17 years. Given the green value of trees in the environment and the fact that trees do not reach their maximum potential until 25-35 years the urban forest has only minimal effect on the environment.
- The speakers were advocating the need for a long term management program to care for trees on an ongoing basis and the monitoring of the urban canopy and how it changes over time. Important to the process was the formation of strategies to help the urban forest along. Use of technology to track progress or the lack of progress over time. Important to the process is the top down approach which looks at tree canopy and not necessarily the number of trees.
- Comparison: 500 2" red maples would not equal the benefits of one mature white oak with a 60 foot diameter canopy.

Practical applications for HEPD.

- The district should not only look at just planting trees but also develop programs and or strategies to see that the planted have an acceptable chance of developing into mature trees with large canopies for the benefit of the environment.

Gary Buczkowski IPRA 2015 1-23-1-25-2015

CONFERENCE EDUCATION SUMMARY FORM

IAPD/IPRA CONFERENCE

JANUARY 2017

PROGRAM SESSION NUMBER 205

TITLE OF SESSION Pest Risk Analysis

PRESENTER(S) Tricia Betake

1. What knowledge/information was of value to you/Hoffman Estates Park District?

Some key points were how to utilize GIS to map
and inventory trees to help manage forested areas
that may be susceptible to serious pests and tree
diseases.

2. Practical applications for HEPD.

A tree inventory would be highly valuable to the
district, especially considering we have the GIS mapping
capabilities and administrator to be able to better manage
our timber stands so that we may minimize the effect
of a major disease or pest outbreak.

SUBMITTED BY: Steve Bessette

PLEASE FILL IN THIS FORM (OR ONE OF YOUR OWN) FOR EACH SESSION YOU ATTEND.
SUBMIT FORM/DOCUMENTATION TO JANE.

AFTER ALL FORMS ARE SUBMITTED, YOU MAY VIEW EVERYONE'S DOCUMENTATION BY
LOGGING ONTO GOOGLE DOCS. ENTER USER NAME: BESTAHOFFMAN@GMAIL.COM -
PASSWORD: HEPARKS2012 ~ THEY ARE ALSO ON THE DISTRICT'S SHARED DRIVE.

212 Up a Creek

Presenter: Ted Grey & Champaign Urbana Park District environmentalist

What knowledge/ information was of value to HEPD?

This program outlined the activities and permitting process required by IDNR and Army Corps of Engineers for an improvement to a headwater creek in central Illinois. The example demonstrated how to deal with agricultural run-off in the form of field nutrients. The Agencies involved made a point to get public input and support for the project. Latest engineering methods for mitigating erosion were shown as examples and yet keep a natural appearance with an environmentally sensitive approach.

Permitting for the project was the timeliest part of the project. 5 mnths+
Due to good weather and working conditions, the 4000 foot project was built in less than three weeks time and has now established itself to filter out the nutrient infiltration and maintain bank soil stability. Area residents enjoy the creek as part of their recreational experience where before it was an eyesore of overgrown invasive plants. The greatest benefit of the project was improved water quality downstream.

Practical applications for HEPD.

The district should look to do similar projects within the creeks and drainage ditches of the district. If accomplished correctly the water quality of our ponds might be improved as a result.

Gary Buczkowski IPRA 2017 1-19-1-21-2017

RECREATION

CONFERENCE EDUCATION SUMMARY FORM

IAPD/IPRA CONFERENCE

JANUARY 2017

PROGRAM SESSION NUMBER #403

TITLE OF SESSION Blowing off STEAM!

PRESENTER(S) Katie Hicks + Tiffany White

1. What knowledge/information was of value to you/Hoffman Estates Park District?

Science, Technology, Engineering, Art + Mathematics.
Art is a key component
Bring in experts from local colleges at lower cost.
- Hands on learning, no pressure, problem solving skill,
practical communication, real-world applications

2. Practical applications for HEPD.

A break from traditional park programs.

SUBMITTED BY: Josely

PLEASE FILL IN THIS FORM (OR ONE OF YOUR OWN) FOR EACH SESSION YOU ATTEND.
SUBMIT FORM/DOCUMENTATION TO JANE.

AFTER ALL FORMS ARE SUBMITTED, YOU MAY VIEW EVERYONE'S DOCUMENTATION BY LOGGING ONTO GOOGLE DOCS. ENTER USER NAME: BESTAHOFFMAN@GMAIL.COM - PASSWORD: HEPARKS2012 ~ THEY ARE ALSO ON THE DISTRICT'S SHARED DRIVE.

Blowing Off STEAM!



Katie Hicks, Douglass Park Coordinator for the Champaign Park District
 Tiffany White, Douglass Park Manager for the Champaign Park District

Who we are and what we do

Katie Hicks
 Douglass Park Program Coordinator
 Katherine.hicks@champaignparks.com
 217.819.3973

Tiffany White
 Douglass Park Manager
 Tiffany.white@champaignparks.com
 217.819.3971

Goals of Presentation

- ❖ Define STEAM
- ❖ Understand the current familiarity with STEAM and the utilization of STEAM programming in parks and recreation.
- ❖ Hands-on examples

What is STEAM Programming?

- ❖ Science
- ❖ Technology
- ❖ Engineering
- ❖ Arts
- ❖ Mathematics

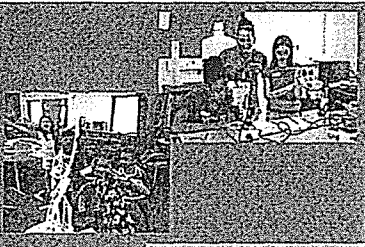

For more information, contact the STEAM Program at info@steamprogram.org or www.steam.gov

Moving from STEM to STEAM

- ❖ Arts education is key to creativity
- ❖ Creativity leads to innovation
- ❖ Innovation is needed to come up with new ideas

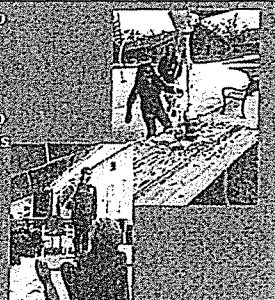

How to Integrate STEAM Programming into Your Agency

You don't need to be an expert to integrate STEAM into your program.



There are many ways to integrate STEAM programming into your agency's curriculum, including:

- Hands-on learning
- Project-based learning
- Cross-curricular instruction
- Guest speakers
- Field trips
- Competitions

How to Integrate STEAM Programming into Your Agency

Necessary to utilize partnerships:
- F.R. forest preserves / conservation areas
- local high school or university

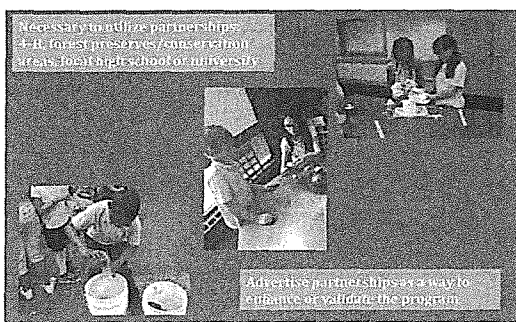

Adaptive partnerships are a way to enhance or validate the program

Why is STEAM important to kids?

- ❖ Hands-on inquiry based learning
- ❖ Develop critical thinking skills
- ❖ Gives kids a chance to be creative
- ❖ Participate in problem solving
- ❖ Be innovative
- ❖ Practice communication
- ❖ Real-world applications



Why incorporate STEAM into programming at your agency?

- ❖ No pressure of grades
- ❖ Participants get to collaborate with each other
- ❖ Steps away from the traditional park programs
- ❖ A chance to reach kids who may not have opportunities to be exposed to STEAM
- ❖ Develop partnerships
- ❖ Low cost

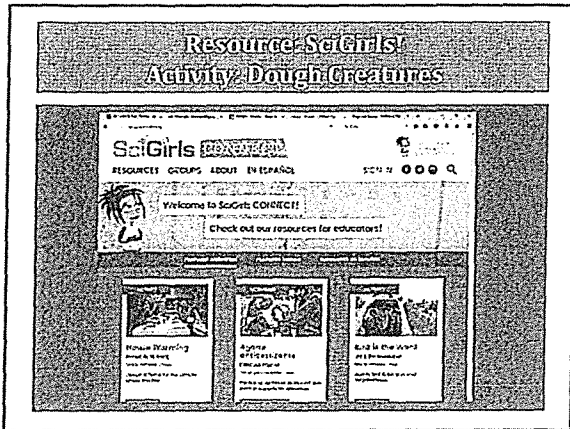

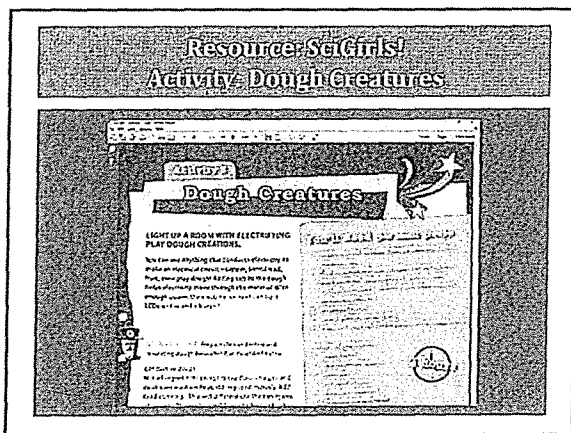

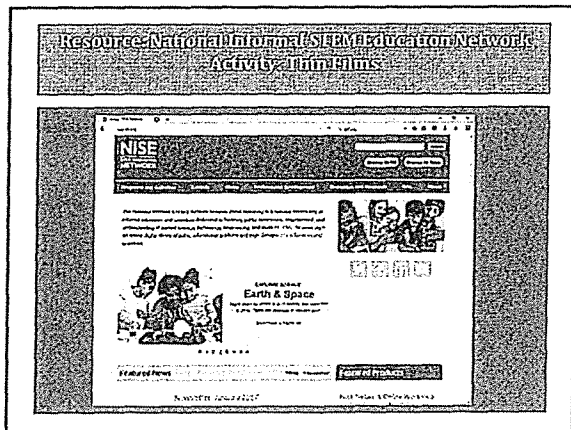

Resource: National Informal STEM Education Network

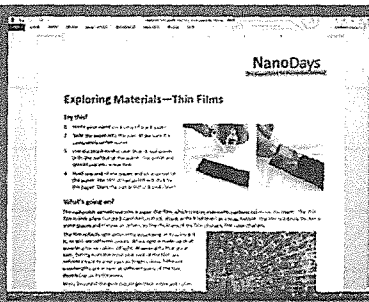

The screenshot shows a webpage from NanoDays with the title "Exploring Materials—Thin Films". It includes a list of steps for an activity, a "What's going on?" section with a microscopic image, and a "Materials" list. The steps are: 1. Prepare your materials, 2. Take the materials to the classroom, 3. Use the materials to create thin films, 4. Measure the thickness of the films, 5. Measure the refractive index of the films. The "What's going on?" section explains that thin films are used in many applications, such as in the coatings on lenses and mirrors. The "Materials" list includes: 1. Glass microscope slides, 2. Aluminum foil, 3. Paper, 4. Tape, 5. Scissors, 6. Ruler, 7. Marker, 8. Paper, 9. Paper, 10. Paper.

Resource: Family Engineering Book Activity: Glue is the Clue



The screenshot shows a webpage titled "FAMILY ENGINEERING" with the subtitle "Bring engineering to life!". It features a "How to Get Involved with Family Engineering" section with four numbered steps: 1. Get involved with family engineering, 2. Find a family engineering activity, 3. Get involved with family engineering, 4. Get involved with family engineering. There are also images of a book and a family.

Resource: Family Engineering Book Activity: Glue is the Clue

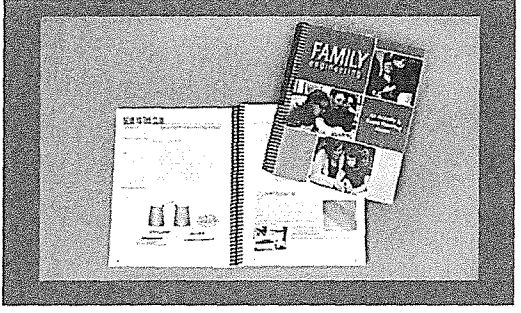

The image shows a spiral-bound book titled "FAMILY ENGINEERING" and a worksheet titled "Glue is the Clue". The book cover features a family and the text "Bring engineering to life!". The worksheet has a grid and some text.

Thank you for attending!
Session 403 Blowing off STEAM!

Please complete a session/workshop evaluation:

Mobile App:

- Search "IAPD/IPRA Conference" and download the app from Apple App or Google Play Store
- Login by entering your email (used for registration) and the password "STNH2017" (case sensitive). Note: If you've logged into the app once, you do not need to login again unless you have logged out of the app.
- Click on the Agenda button and search for the session by title, session ID or speaker. Once found, click into the session listing and then click on the session survey.

Paper Evaluation: Raise your hand for one.



Activity 3

Dough Creatures

LIGHT UP A ROOM WITH ELECTRIFYING PLAY DOUGH CREATIONS.

You can use anything that conducts electricity to make an electrical circuit—copper, pencil lead, fruit, even play dough! Adding salt to the dough helps electricity move through the material. With enough power, the electrical current can light LEDs and sound a buzzer!



SMART START: Prepare the conductive and insulating dough beforehand, as described below.

Conductive dough

Mix all ingredients except $\frac{1}{2}$ cup flour in a pot and cook over medium heat, stirring continuously. Add food coloring. (This will differentiate the two types of dough.) The mixture will begin to boil and get chunky. Keep stirring until a ball forms in the center of the pot, then remove the saucepan from the heat. **CAUTION:** The dough will be very hot! Allow it to cool before handling. Once cooled, mix flour into the dough until it is firm, but moldable.

Insulating dough

Mix the oil and solid ingredients (setting aside $\frac{1}{2}$ cup flour) in a bowl. Mix in 1 tbsp. deionized water and stir. Continue to add deionized water 1 tbsp. at a time until the mixture becomes moist and dough-like. Remove it from the bowl and slowly knead in flour until the desired consistency is reached.

Store the dough in an airtight container until needed. It will keep for 3 weeks.

You'll Need (per small group):

- ◆ conductive and insulating dough (See Smart Start for directions.)
- ◆ 4 AA batteries with battery holder or one 9 V with snap connector (RadioShack or sparkfun.com)
- ◆ 4-8 LEDs, 1.9–2.4 V / 20 mA–40 mA (RadioShack or evilmadscience.com)
- ◆ paper and pencil
- ◆ safety glasses (for each girl)
- ◆ optional: assorted craft supplies (straws, sticks, etc.)

For dough preparation:

- ◆ mixing bowl
- ◆ wooden mixing spoon
- ◆ saucepan
- ◆ hot plate or stove
- ◆ 2 airtight containers
- ◆ measuring cups/spoons



For conductive dough (makes enough for 3-4 girls):

- ◆ $1\frac{1}{2}$ cups flour
- ◆ 1 cup water
- ◆ $\frac{1}{4}$ cup salt
- ◆ 3 tbsp. cream of tartar
- ◆ 1 tbsp. vegetable oil
- ◆ food coloring

For insulating dough (makes enough for 3-4 girls):

- ◆ $1\frac{1}{2}$ cups flour
- ◆ $\frac{1}{2}$ cup sugar
- ◆ 3 tbsp. vegetable oil
- ◆ $\frac{1}{2}$ cup deionized or distilled water
- ◆ optional: 1 tsp. granulated alum (preservative)

Dough Creatures

continued

Here's how:

1. Introduce insulators and conductors. Ask girls what a conductor is. (A material that allows energy, such as heat, electricity, light or sound, to pass through easily.) What materials make good electrical conductors? (salt water, metals such as copper, gold, aluminum) What is an insulator? (A material that does not allow energy to pass through easily.) What materials make good electrical insulators? (glass, rubber, plastic, cotton) Why might electric circuits include insulating materials? (Insulation protects us from wires that might give us a shock and helps direct the flow of electricity.)

Never connect the LED directly to the battery! It could shatter the LED. Always use dough to add resistance



2. Build a simple circuit. Break into small groups¹ and pass out some conductive dough, batteries, battery holders, and LEDs. Have girls brainstorm and sketch a simple circuit that uses these materials. (A circuit is a closed loop, allowing electricity to flow in a circle.) Insert the two terminals from a battery holder or connector into two pieces of conductive dough. Insert an LED into both pieces of dough, so the positive lead (longer leg) is attached to the positive terminal of the battery and the negative lead (shorter leg) is attached to the negative terminal of the battery. (See above, right.) Have girls discuss why the LED lights up.⁶ (For current to flow, there must be a complete path from one pole of the battery, through the wire, to the light, and back to the other pole of the battery.)



POINTER: If the girls have never worked with LEDs before, see the Smart Start on page 9.

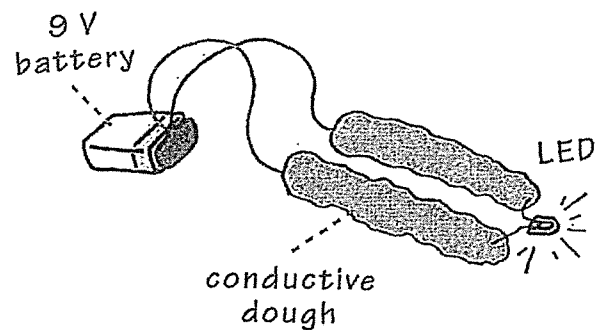

3. Experiment. What happens if two pieces of conductive dough touch? Have girls test this. (The bulb will not light because you created a short circuit.) What happens if insulating dough is placed between the two pieces of conductive dough? (See below.)

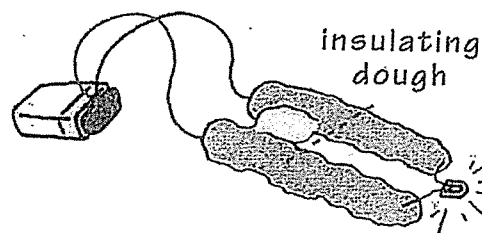
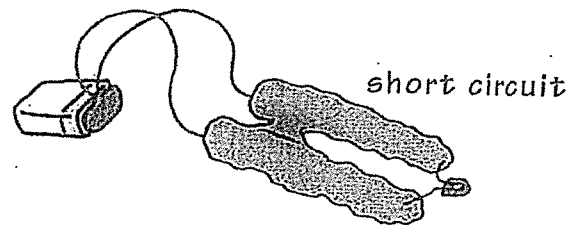

Dough Creatures continued

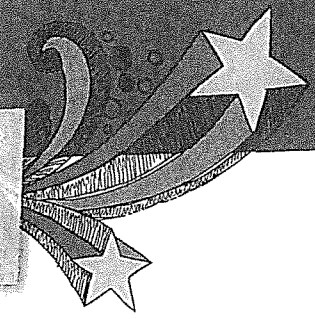

4. Brainstorm. Introduce the SciGirls Challenge:

Use conductive and insulating dough to make battery-powered creatures that light up. Ask each group to brainstorm possible creature designs. They should consider using sticks, straws, or other materials as supporting structures.

5. Sketch and build. Have groups draw sketches and then agree on one design to build.³

6. Test. If girls are having problems getting the creature to perform a complicated task, encourage them to start small.⁵ Suggest they first try to achieve a simpler function, such as getting one eye to light up, and then, once they have accomplished this, move on to a more complicated task, such as getting two eyes to light. (See right for examples.)

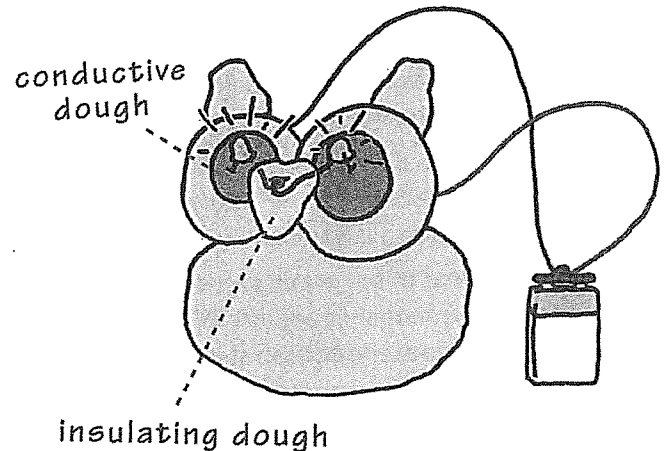

Special thanks to AnnMarie Thomas, an engineering professor at the University of St. Thomas in Minnesota, for contributing her ideas and expertise. Dr. Thomas is co-director of the Center for Pre-Collegiate Engineering Education. She worked with engineering student Samuel Johnson to develop this activity.

POINTER: Remind girls that dough does not conduct as well as metal. They may find it helpful to use small chunks of dough (to reduce resistance) or check that all LEDs require the same voltage.



7. Share. When everyone is done, have groups demonstrate their creations and discuss. Talk about possible real world uses for the creatures.² If they could design an enhanced creature, what would they have it do? For additional ideas, visit courseweb.stthomas.edu/apthomas/SquishyCircuits.

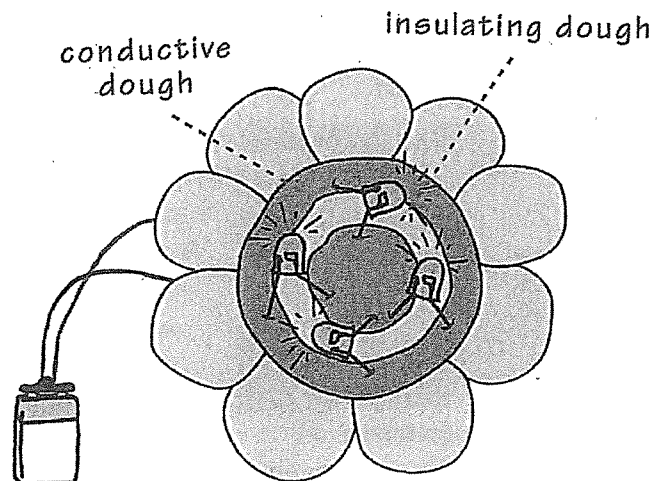

Exploring Materials—Thin Films

Try this!

1. Write your name on a strip of black paper.
2. Slide the paper into the pan. Make sure it's completely under water.
3. Use the brush to drip one drop of nail polish onto the surface of the water. The polish will spread out into a thin film.
4. Hold one end of the paper and lift it up out of the water. The film of nail polish will stick to the paper. Does the nail polish still look clear?

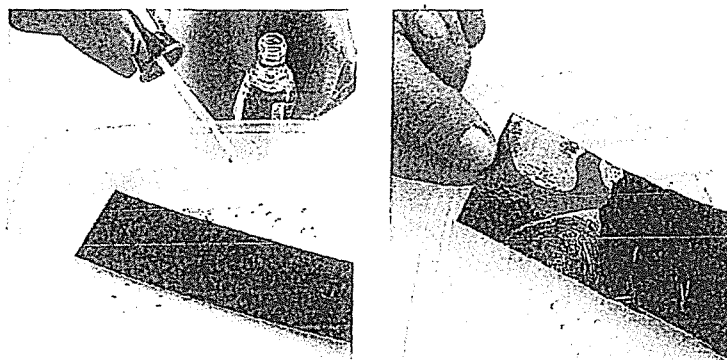

What's going on?

The nail polish spreads out into a super-thin film, which creates iridescent, rainbow colors on the paper. The thin film is only a few hundred nanometers thick, about as thick (or thin!) as a soap bubble. The film is slightly thicker in some places and thinner in others. As the thickness of the film changes, the color changes.

The film reflects light differently depending on how thick it is, so you see different colors. White light is made up of all wavelengths, or colors, of light. Wavelengths that are in sync, hitting both the front and back of the film, are reflected back to your eyes as bright colors. Different wavelengths are in sync at different parts of the film, depending on its thickness.

Many beautiful things in nature get their iridescent colors this way—through the constructive interference of light. Bird feathers, butterfly wings, shells, and beetle shells all have nano-sized, semi-transparent layers that create an iridescent effect when they reflect light.

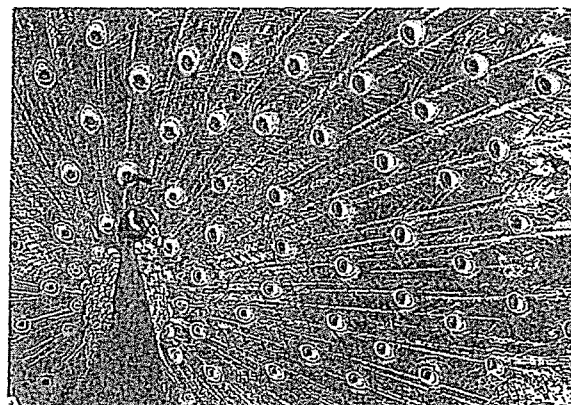

Peacock feathers are iridescent

How is this nano?

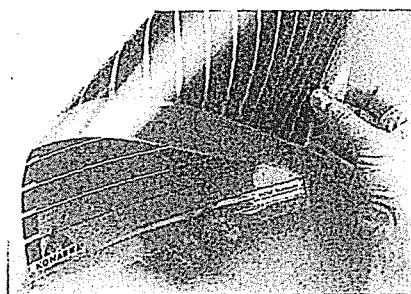

Thin film solar panel

The way a material behaves on the macroscale is affected by its structure on the nanoscale. Thin films can reflect light in special ways, because they're only a few hundred nanometers thick—in the same size range as the wavelength of visible light.

Nanotechnology takes advantage of special properties at the nanoscale to create new materials and devices. Researchers are creating thin film batteries, solar cells, electronic displays, and coatings for different surfaces.

Thin Film Background Information

What are thin films?

A thin film is a layer of material ranging from less than a nanometer (one billionth of a meter) to several micrometers thick. Everyday examples of thin films include soap bubbles, oil slicks on water, and anti-reflection coating on eyeglasses.

Why do some thin films have beautiful colors?

Light travels in waves. Just like water waves, light waves have crests (high points) and troughs (low points). The distance between crests is a *wavelength*. Different colors of light have different wavelengths.

The wavelength of visible light ranges from about 400-700 nanometers. The nanostructures of iridescent feathers, shells, and wings are in this same size range. So are thin films.

Light can interact in special ways with very tiny structures, like those found in nature and in nanotechnology.

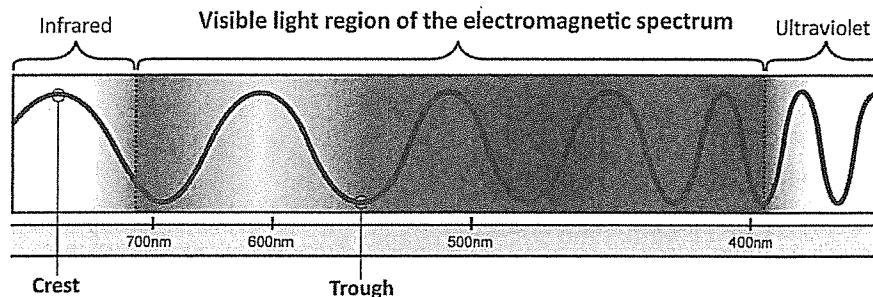

White light is made up of all wavelengths, or colors, of light. When white light hits a thin film, some of the light is reflected from the front surface of the film, and some travels through it and is reflected from the back surface.

Constructive interference

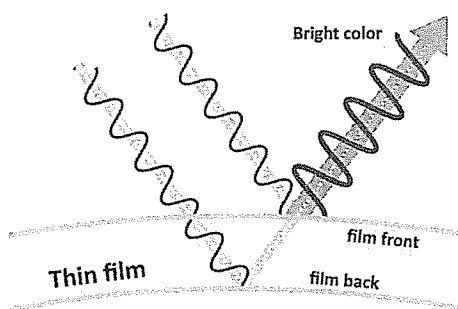

Destructive interference

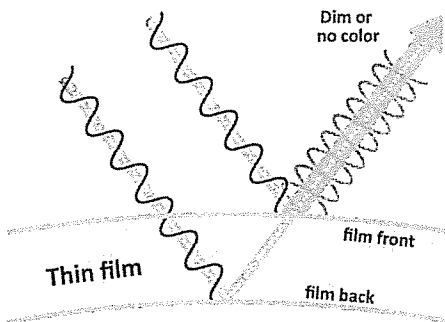

If the waves reflected from the front and back have crests that overlap, they reinforce each other and the reflected color is bright. This is called *constructive interference*.

If the waves reflected from the front and back have crests that overlap with troughs, the waves cancel each other out and the reflected color is dim. This is called *destructive interference*.

The thickness of the film determines which colors will be bright and which will be cancelled out. In a very thin film (less than 400 nanometers thick) all the colors cancel out, and the film appears black.

How are thin films used?

Scientists are developing thin films to use as computer memory and in solar cells. Flexible thin film batteries can be made by printing onto plastic, thin metal foil or paper. Thin films are expected to have cheaper manufacturing and materials costs than conventional materials.

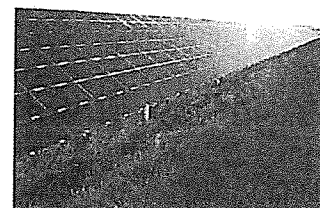

Thin film solar panels

Learning objectives

1. The way a material behaves on the macroscale is affected by its structure on the nanoscale.
2. The thin film reflects light differently depending on how thick it is, so you see different colors.

Materials

- Shallow pan
- Strips of black paper
- Clear nail polish
- Permanent markers in metallic color
- Peacock feather (optional)
- Thin film solar cell sample (optional)

Bristol paper works best for this activity. You can use regular construction paper, but a lot of color will bleed from the paper into the water.

The nail polish should be completely clear (no shimmer or glitter), and regular formula (not fast-drying).

Notes to the presenter

SAFETY: Do this activity in a well-ventilated area.

Before you begin:

- Fill the pans halfway with water.
- Set up an area to let the strips of paper dry.

Black paper is used for this activity because it absorbs all visible light. The colors that appear are created by the interaction of light with the thin film.

Writing their name with the permanent marker helps visitors find their thin film later. The marker doesn't make the colors appear on the black paper—that's the thin film created by the nail polish.

Related educational resources

The NISE Network website (www.nisenet.org) contains additional resources to introduce visitors to nanomaterials:

- Public programs include *Aerogel*, *Biomimicry: Synthetic Gecko Tape Through Nanomolding*, *Nanoparticle Stained Glass*, *Nanosilver: Breakthrough or Biohazard?* and *World of Carbon Nanotubes*.
- NanoDays activities include *Exploring Materials—Ferrofluid*, *Exploring Materials—Liquid Crystals*, and *Exploring Structures—Buckyballs*.
- Exhibits include *Bump and Roll*, *Changing Colors*, and *Unexpected Properties*.

Credits and rights

This activity was adapted from "Create Some Iridescent Art," in the *DragonflyTV Nano Educator's Guide*, published by Twin Cities Public Television, 2009. The original activity is available at:

www-tc.pbskids.org/dragonflytv//web_assets/pdf/dftv_nanoedguide_butterflywings.pdf

Illustration of interfering wavelengths of light by Emily Maletz.

Photo of solar panel array in the public domain, from Wikimedia.



This project was supported by the National Science Foundation under Award No. 0940143. Any opinions, findings, and conclusions or recommendations expressed in this program are those of the author and do not necessarily reflect the views of the Foundation.

Copyright 2010, Sciencenter, Ithaca, NY. Published under a Creative Commons Attribution-Noncommercial-ShareAlike license: <http://creativecommons.org/licenses/by-nc-sa/3.0/us/>

GLUE IS THE CLUE

Engineering Fields

- materials engineering
- chemical engineering

Engineering Concepts & Skills

- role of failure
- controlled experimentation and testing

Supplies

- 4 colored index cards (4" x 6"), 2 of one color and 2 of another color
- 2 plastic cups (12 oz. or larger)
- 30 flat metal washers (1-1/2" diameter)
- container to hold washers
- Glue is the Clue activity sign (Appendix A)

Advance Preparation Supplies

- glue stick
- ruler
- marker
- tape

Can an engineer make something stronger?

Advance Preparation

- Glue two index cards, one of each color, together like a sandwich. Allow them to dry thoroughly. Label both sides with the word "glued" across the top (see below).
- Label both sides of the remaining cards, one of each color, with the word "unglued" across the top.
- Draw a 2-inch diameter circle in the center on both sides of each pair of cards. This will indicate where the washers should be stacked to ensure a fair test.
- Set the two cups upside down on the table surface so that there are 4 inches between the tops of the cups. Tape them to the table to prevent them from moving.

SAMPLE OPENER ACTIVITY

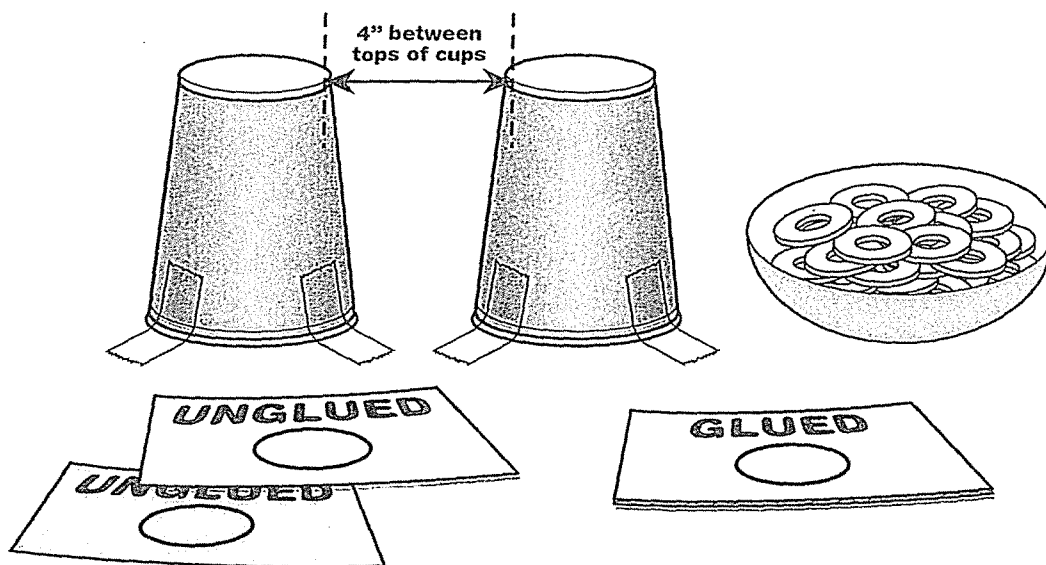

Activity Steps

1. Stack the two **unglued** cards together and place them across the top of the two cups like a bridge. How many washers do you think the cards will hold before collapsing?
2. Carefully stack the washers in the circle on the top card, counting them as they are added. Keep going until the cards collapse.
3. Now, repeat with the **glued** cards. How many washers do you think the **glued** cards will hold?
4. Which pair of cards held more washers? Why?

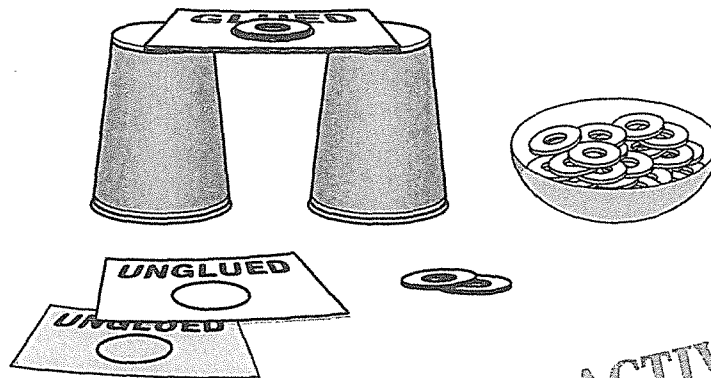

SAMPLE OPENER ACTIVITY

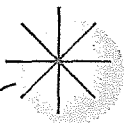

ENGINEERING CONNECTION

The two **glued** cards stay together, becoming a single, thicker card with greater strength. The two **unglued** cards do not work as well together to hold up weight because they can bend and slide apart.

Gluing layers of material together is called **lamination**. Plywood is an engineered wood product that uses lamination. To make plywood, chemical engineers developed a special glue to hold many thin layers of wood together. This makes plywood stronger than solid wood of the same thickness.

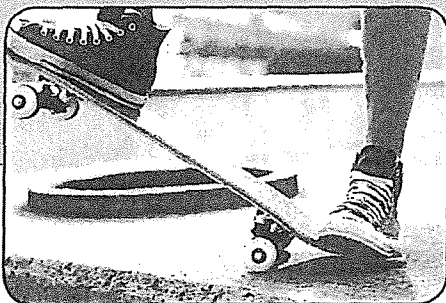

Skateboards are made out of plywood so that they can be both strong and lightweight.

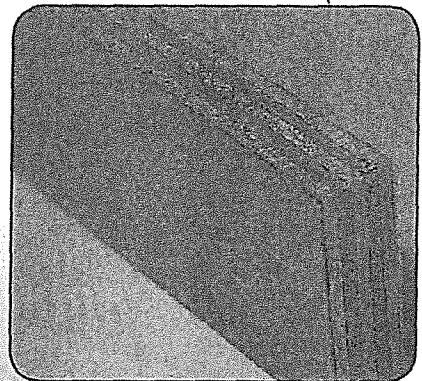

total - "Reel test" - first-aid - information.

67

CONFERENCE EDUCATION SUMMARY FORM

IAPD/IPRA CONFERENCE

JANUARY 2017

PROGRAM SESSION NUMBER #424

TITLE OF SESSION Captain No Fun's Guide to Safety at your Next Event

PRESENTER(S) Tim Beckmann

1. What knowledge/information was of value to you/Hoffman Estates Park District?

- Have all staff be involved with Safety Training. Those that do the events have lots of input. - Do a hands on training not just a mtg.
- outdoor events - have staff w/ walkie talkies so staff can be notified before causing panic.
- Have building sectioned off into zones. - designate zones to staff.

2. Practical applications for HEPD.

- PDRMA - event helper - contractors - can get 1 day event insurance.
- safety event checklist
- Active shooter - avoid - be aware of surroundings / Deny access to your location
- Defend yourself - you have that right
- have back down drills - involve police department.

SUBMITTED BY: Jody

PLEASE FILL IN THIS FORM (OR ONE OF YOUR OWN) FOR EACH SESSION YOU ATTEND.
SUBMIT FORM/DOCUMENTATION TO JANE.

AFTER ALL FORMS ARE SUBMITTED, YOU MAY VIEW EVERYONE'S DOCUMENTATION BY LOGGING ONTO GOOGLE DOCS. ENTER USER NAME: BESTAHOFFMAN@GMAIL.COM - PASSWORD: HEPARKS2012 ~ THEY ARE ALSO ON THE DISTRICT'S SHARED DRIVE.

CONFERENCE EDUCATION SUMMARY FORM

IAPD/IPRA CONFERENCE

JANUARY 2017

PROGRAM SESSION NUMBER 424

TITLE OF SESSION Captain No Falls Guide to Safety @ your next event

PRESENTER(S) Tom Beckman Mingo Grove P.D.

1. What knowledge/information was of value to you/Hoffman Estates Park District?

- include all staff in Safety Trainings that attend events
- Do hands on Trainings not just a mtg.
- Outdwn events - have all staff see practice Talker @ event
- Sectional Coms of outdwn events

2. Practical applications for HEPD.

- Active Shooter Run / Hide / Fight
- Review Active Shooter video : policy for HEPD.
- Review Lock down drills for HEPD.

SUBMITTED BY: Shang Jung

PLEASE FILL IN THIS FORM (OR ONE OF YOUR OWN) FOR EACH SESSION YOU ATTEND. SUBMIT FORM/DOCUMENTATION TO JANE.

AFTER ALL FORMS ARE SUBMITTED, YOU MAY VIEW EVERYONE'S DOCUMENTATION BY LOGGING ONTO GOOGLE DOCS. ENTER USER NAME: BESTAHOFFMAN@GMAIL.COM - PASSWORD: HEPARKS2012 ~ THEY ARE ALSO ON THE DISTRICT'S SHARED DRIVE.

CONFERENCE EDUCATION SUMMARY FORM

IAPD/IPRA CONFERENCE

JANUARY 2017

PROGRAM SESSION NUMBER Enjoy the Ride
 TITLE OF SESSION Key Note Speaker
 PRESENTER(S) Steve Gilliland

1. What knowledge/information was of value to you/Hoffman Estates Park District?

Find/discover your passion - if not currently
doing it - develop plan or strategy how you
move in that direction.
Live/be in the moment

2. Practical applications for HEPD.

- Encourage parents to turn off phone
while attending their childrens games, show
ect.

SUBMITTED BY: Dean Bosman

PLEASE FILL IN THIS FORM (OR ONE OF YOUR OWN) FOR EACH SESSION YOU ATTEND.
SUBMIT FORM/DOCUMENTATION TO JANE.

AFTER ALL FORMS ARE SUBMITTED, YOU MAY VIEW EVERYONE'S DOCUMENTATION BY LOGGING ONTO GOOGLE DOCS. ENTER USER NAME: BESTAHOFFMAN@GMAIL.COM - PASSWORD: HEPARKS2012 ~ THEY ARE ALSO ON THE DISTRICT'S SHARED DRIVE.

CONFERENCE EDUCATION SUMMARY FORM

IAPD/IPRA CONFERENCE

JANUARY 2017

PROGRAM SESSION NUMBER _____

TITLE OF SESSION Keynote speaker - Enjoy the ride

PRESENTER(S) Steve Gilliland

1. What knowledge/information was of value to you/Hoffman Estates Park District?

- Enjoy the ride - never allow people to run your day
- Assign the right value to situations - don't inflate the value doesn't improve the situation don't do it, don't say it

2. Practical applications for HEPD.

- Cure destination ~~disease~~ disease - what's next

SUBMITTED BY: Martha Houston

PLEASE FILL IN THIS FORM (OR ONE OF YOUR OWN) FOR EACH SESSION YOU ATTEND. SUBMIT FORM/DOCUMENTATION TO JANE.

AFTER ALL FORMS ARE SUBMITTED, YOU MAY VIEW EVERYONE'S DOCUMENTATION BY LOGGING ONTO GOOGLE DOCS. ENTER USER NAME: BESTAHOFFMAN@GMAIL.COM - PASSWORD: HEPARKS2012 ~ THEY ARE ALSO ON THE DISTRICT'S SHARED DRIVE.

CONFERENCE EDUCATION SUMMARY FORM

IAPD/IPRA CONFERENCE

JANUARY 2017

PROGRAM SESSION NUMBER Keynote General Session
 TITLE OF SESSION Enjoy the Ride
 PRESENTER(S) Steve Gilliland

1. What knowledge/information was of value to you/Hoffman Estates Park District?

Steve had a wonderful sense of humor
and valuable advice for the busy professional.
Slow down and enjoy the ride!

2. Practical applications for HEPD.

Slow down and enjoy the moments! Don't
let all the work and little things make
you forget to Enjoy the Ride!
I will be sharing his books with my staff

SUBMITTED BY: Wendy Stoner

PLEASE FILL IN THIS FORM (OR ONE OF YOUR OWN) FOR EACH SESSION YOU ATTEND.
SUBMIT FORM/DOCUMENTATION TO JANE.

AFTER ALL FORMS ARE SUBMITTED, YOU MAY VIEW EVERYONE'S DOCUMENTATION BY LOGGING ONTO GOOGLE DOCS. ENTER USER NAME: BESTAHOFFMAN@GMAIL.COM - PASSWORD: HEPARKS2012 ~ THEY ARE ALSO ON THE DISTRICT'S SHARED DRIVE.

CONFERENCE EDUCATION SUMMARY FORM

IAPD/IPRA CONFERENCE

JANUARY 2017

PROGRAM SESSION NUMBER # 410

TITLE OF SESSION Fire, Shelter, Water - Can You Survive?

PRESENTER(S) Jessica Reyes, Naturalist

1. What knowledge/information was of value to you/Hoffman Estates Park District?

There are several TV shows available on the subject of survival -
Young children are watching and are interested. Why not have a
survival type program offered by your PK District? Prepare kids -
(1st - 6th graders) to be ready for whatever comes next. Let kids do
"Dangerous things," matches, fire building, knives, etc...
let them build their self-confidence

2. Practical applications for HEPD. Possible Program to offer or Build.

Suggested program to tie in with Archery possibly - kind of an
Eagle Scout feel. Having rules, but simple rules, Instructor
is there for questions, but no answers, children find their own
answers. A very hands-on, get dirty program, providing a
learning experience that Parents are uneasy or not capable of
providing. Kids can manage their own risks in a controlled environment.

SUBMITTED BY: Ron EVANS, Commissioner

PLEASE FILL IN THIS FORM (OR ONE OF YOUR OWN) FOR EACH SESSION YOU ATTEND.
 SUBMIT FORM/DOCUMENTATION TO JANE.

AFTER ALL FORMS ARE SUBMITTED, YOU MAY VIEW EVERYONE'S DOCUMENTATION BY
 LOGGING ONTO GOOGLE DOCS. ENTER USER NAME: BESTAHOFFMAN@GMAIL.COM -
 PASSWORD: HEPARKS2012 ~ THEY ARE ALSO ON THE DISTRICT'S SHARED DRIVE.

CONFERENCE EDUCATION SUMMARY FORM

IAPD/IPRA CONFERENCE

JANUARY 2017

PROGRAM SESSION NUMBER 422

TITLE OF SESSION The Plight of the Middle Manager : The Art of Managing Up

PRESENTER(S) Jai Cole, Chris Matthews

1. What knowledge/information was of value to you/Hoffman Estates Park District?

- Employees who work for engaged managers are 59% more likely to be engaged
- Type of relationship an employee has w/ boss is #1 factor influencing employee engagement
- You can't change your boss, you can only change yourself.

2. Practical applications for HEPD.

- Be an engaged mgr to get most of employees
- Know what your boss is looking for/likes, and be prepared for that when approaching them with a question, problem, etc.

SUBMITTED BY: Colleen Palmer

PLEASE FILL IN THIS FORM (OR ONE OF YOUR OWN) FOR EACH SESSION YOU ATTEND. SUBMIT FORM/DOCUMENTATION TO JANE.

AFTER ALL FORMS ARE SUBMITTED, YOU MAY VIEW EVERYONE'S DOCUMENTATION BY LOGGING ONTO GOOGLE DOCS. ENTER USER NAME: BESTAHOFFMAN@GMAIL.COM - PASSWORD: HEPARKS2012 ~ THEY ARE ALSO ON THE DISTRICT'S SHARED DRIVE.

Dean Bostrom

From: Dean Bostrom
Sent: Monday, January 23, 2017 11:26 AM
To: Dean Bostrom
Subject: The power of Pause #419

Everybody thinks that everyone should respond right away,
 Evernote photo... to do list
 Asana...task assigner with response
 Learn to say no to the ergent

Mindless internet.."the most urgent"
 The average person checks phone 150 times a day
 1 minute 25 seconds interuption in work 25 minutes to refocus

Work as team
 Close door one hour no interuptions

Finding the Flow..Chickemaheah

Makers schedule...bookend meetings...free up middle of the day for projects

Move from river to intermittent stream...rivers constantly flow and flood

Checky..app
 Freckle....app hours and time spend on different task

If you do not fill your calendar with your priorties others will...

How do we find balance? Life - work balance! vs work – life balance...pause tools

1. Be realistics...tasks related to 5 tasks in a day
2. Stay focused hone still....25 minutes uninterrupted..5 minutes break ...walkgo back at it...

Things that are great in your life....what really matters...checking emails at night...on vacation..wreaks your night...vacation...

Paired comparsion analysis..

Every thing in life is a "could do"....things you really want to do (personal and professional) compare list what is greater priority in life...

Which has a deadline to complete

Which highest value

Which easily accomplished

Highest Return on investment

Nearly Miraculoious Daily Habits

Idea catcher

Repetitive tasks..walking..let your mind think

What you really want to do can't get to...dedicate 15 minutes a day every..89 hours. In . ie. write a book a year

Book...The Hamster Revolution...emails..tools cut down emails by 20%..

Pick up the phone if going back and forth

IS what I am going to say improve the situation...Tony Dugey

3 days of no emails...start with one day

If project less than 10 minutes ..get it done right away

Say no to the urgent...

Dean Bostrom, CPRE

Executive Director / Board Secretary

t 847-310-3604 | f 847-885-7523 | e dbostrom@heparks.org

HANDOUTS

- 1. TRANSGENDER**
- 2. LEGAL/LEGISLATIVE PART I**
- 3. LEGAL/LEGISLATIVE PART II**
- 4. REDUCING TORT LIABILITY EXPOSURE**
- 5. EMPLOYEE FRINGE BENEFITS – COMMISSIONER ACCESS TO PROGRAMS, FACILITIES AND ACTIVITIES**
- 6. HOT TOPICS IN EMPLOYMENT**
- 7. DIRECTOR & COMMISSIONERS RELATIONSHIPS**
- 8. IAPD LEGISLATIVE YEAR IN REVIEW**
- 9. ILLINOIS ENERGY NOW REBATES & INCENTIVES**